



QUALITY IN ONE EASY PACKAGE



## QUALCUNO VI OFFRIRÀ UN PRODOTTO CHE SEMBRA COME IL NOSTRO... MA NON È COME IL NOSTRO.

Ogni volta che viene usato, un nostro prodotto è chiamato ad una performance.

Non solo deve avere resistenza, elasticità e durata nel tempo conferitegli da materiali selezionati della massima qualità, deve essere pensato, approvato e certificato per stare a stretto e duraturo contatto con alimenti. E, non ultimo, deve essere...bello! Sì, perché il design degli oggetti che ogni giorno userete ed esporrete, contribuisce in modo importante all'impressione positiva che la clientela avrà della vostra attività ed anche al vostro piacere quotidiano di svolgere la professione maneggiando... piccoli capolavori. Tutte queste qualità non si improvvisano copiandole.

Tutte queste qualità si riassumono in un concetto:

MADE IN ITALY.

MADE IN ITALY vuol dire cultura della qualità.

MADE IN ITALY vuol dire il top-design famoso nel mondo.

E non a caso MADE IN ITALY vuol dire... un mito in cucina!

*Each time it's used, our product is called to a performance. It must not only have strength, elasticity and durability bestowed by selected materials of the highest quality; but it must be designed, approved and certified to stay all the time in contact with food.*

*And last but by no means least... it must be cool!*

*The design of objects that are for every day use will give an important, positive impression on your customers view of your business.*

*And you will also enjoy handling... these small works of art. All these qualities can't be copied.*

*All these qualities can be summed up into one concept: MADE IN ITALY*

*MADE IN ITALY means the culture of quality.*

*MADE IN ITALY means top-design throughout the world.*

*Not by chance MADE IN ITALY means... a legend in the kitchen!*

## SOMEONE WILL OFFER YOU A PRODUCT SIMILAR TO OURS... BUT IT'S NOT LIKE OURS.

Prodotti INOX MACEL un piccolo, quotidiano spettacolo.

INOX MACEL condivide il lavoro dei professionisti della ristorazione: dai più piccoli accessori agli oggetti più importanti e vistosi da esporre al pubblico. Ganci, vassoi, serie Gastronorm, gelateria, cestelli per lavastoviglie, lavelli, carrelli e articoli per la tavola.

In ogni specialità... il top della performance e dello stile.

*INOX MACEL products a small daily wonder.*

*INOX MACEL supports the efforts of catering professionals: from the smallest accessories to the more important and flashy items to show to the public. Hooks, trays, Gastronorm containers, ice-cream tools, racks for dishwashers, sinks, trolleys and tableware. In every specialty... the top performance and style.*



<i>GASTRONORM Gastronorm</i>	<b>2</b>
<i>BACINELLE GELATO Ice-cream basins</i>	<b>22</b>
<i>VASSOI E CONTENITORI INOX Steel trays and containers</i>	<b>28</b>
<i>CONTENITORI "PIZZA" 60X40 Pizza dough 60x40 containers</i>	<b>32</b>
<i>ARTICOLI PER LA TAVOLA Tableware</i>	<b>33</b>
<i>BROCCHIE Pitchers</i>	
<i>BICCHIERI Glasses</i>	
<i>VASSOI Trays</i>	
<i>PIATTI, COPRIPIATTI, INSALATIERE plates, cover plates salad bowls</i>	
<i>LAVELLI Sinks</i>	<b>42</b>
<i>CARRELLI Trolleys</i>	<b>52</b>
<i>GANCI Hooks</i>	<b>58</b>
<i>CESTELLI PER LAVASTOVIGLIE Dishwasher baskets</i>	<b>68</b>





## GASTRONORM

*Gastronorm*

Robuste, forti e indistruttibili.  
Una "squadra" perfettamente assortita  
e soprattutto... vincente!  
GASTRONORM è una serie di prodotti  
sovrapponibili e impilabili:  
l'unione fa la forza.

*Robust, strong and indestructible.  
A "team" with a perfect range and  
above all a winner!  
GASTRONORM is a series of  
interchangeable and stackable  
products: unity is strength.*



S/S AISI 304



ENAMELLED



POLYCARBONATE



POLYPROPYLENE



CON GRADINO  
With edge rim



SENZA GRADINO  
Without edge rim

bordo arrotondato (con "gradino"):  
rounded edge (with "edge rim"): code TG

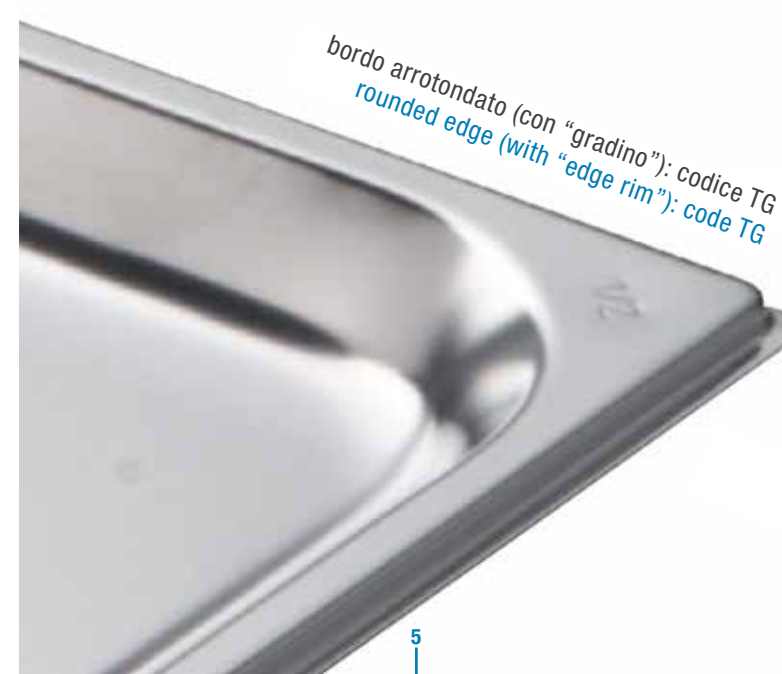

bordo piatto:  
flat edge: code TL





**CONTENITORI GASTRONORM**  
**AISI 304 con gradino di impilabilità**  
*Aisi 304 gastronorm containers*  
*with stacking collar*



CODICE Code	H in mm H in mm	DIM. ESTERNE mm ext. dimens. mm	cap. Lt. cap. lt.
----------------	--------------------	------------------------------------	----------------------

**MOD. 2/1**

BA21065	65	650x530	20,2
BA21100	100	650x530	31,0
21150	150	650x530	46,5
21200	200	650x530	62,0

**MOD. 1/1**

11065	65	530x325	9,8
11100	100	530x325	15,0
11150	150	530x325	22,5
11200	200	530x325	30,0

**MOD. 2/4**

24065	65	530x162	4,5
24100	100	530x162	6,9
24150	150	530x162	13,8

**MOD. 2/3**

23150	150	354x325	14,8
23200	200	354x325	19,7
BA23065	65	354x325	6,4
BA23100	100	354x325	9,9

**MOD. 1/2**

12150	150	325x265	10,8
12200	200	325x265	14,4
BA12065	65	325x265	4,7
BA12100	100	325x265	7,2

**MOD. 1/3**

13150	150	325x176	6,8
13200	200	325x176	9,0
BA13065	65	325x176	2,9
BA13100	100	325x176	4,5



CODICE Code	H in mm H in mm	DIM. ESTERNE mm ext. dimens. mm	cap. Lt. cap. lt.
----------------	--------------------	------------------------------------	----------------------

**MOD. 1/4**

14150	150	265x162	4,9
14200	200	265x162	6,5

**MOD. 1/6**

16065	65	176x162	1,4
16100	100	176x162	2,1
16150	150	176x162	3,2
16200	200	176x162	4,3

**MOD. 1/9**

19065	65	176x108	1,3
19100	100	176x108	0,8

**MOD. 2/8**

28055	55	132x325	1,8
-------	----	---------	-----

**CARATTERISTICHE TECNICHE GASTRONORM**

**ACCIAIO INOX AISI 304:**

Il gradino di sovrapposibilità permette d'impilare facilmente le bacinelle senza che si incastrino tra di loro. Compatibili con i contenitori gastronorm in policarbonato. Bagno in elettrolisi per tutti i contenitori altezza 150 e 200 o in alternativa per le altre misure; l'elettrolisi, tipica per gli strumenti chirurgici, garantisce una finitura più liscia e lucida. Prodotte in AISI 304 per garantire massima resistenza alla corrosione, un acciaio autentico e adatto al contatto con alimenti. Ogni pezzo viene controllato e insacchettato uno ad uno per preservarne la superficie e la pulizia.

**AISI304 SST GASTRONORM TECHNICAL FEATURES**

The stacking collars on the walls allow to easily stack and unstack the containers without risks. Compatible with our Gastronorm polycarbonate containers. Electrolysis bath for all the height 150 and 200 containers or alternatively for the other sizes; electrolysis, typical for surgical instruments, ensures a shinier and smoother finishing. Made in AISI 304 to ensure maximum resistance to corrosion, a high quality genuine steel perfect for food contact. Every piece is checked and packed in bags one by one to preserve the surface and the cleaning.

# TEGLIE CON "GRADINO" (bordo arrotondato)

BAKING CONTAINERS WITH "EDGE RIM"  
(rounded edge)

CODICE Code	H in mm H in mm	DIM. ESTERNE mm ext. dimens. mm	cap. Lt. cap. lt.
----------------	--------------------	------------------------------------	----------------------

## MOD. 2/1

TG21020	20	650x530	5,0
TG21040	40	650x530	12,4
TG21065	65	650x530	19,0

## MOD. 1/1

TG11010	10	530x325	1,25
TG11020	20	530x325	2,5
TG11040	40	530x325	5,0
TG11065	65	530x325	6,5

## MOD. 2/4

TG24020	20	530x162	1,2
TG24040	40	530x162	2,4
TG24065	65	530x162	3,6

## MOD. 2/3

TG23020	20	354x325	1,5
TG23040	40	354x325	3,0
TG23065	65	354x325	5,5

## MOD. 1/2

TG12010	10	325x265	0,7
TG12020	20	325x265	1,0
TG12040	40	325x265	2,0
TG12065	65	325x265	4,0

## MOD. 1/3

TG13020	20	325x176	0,7
TG13040	40	325x176	1,8
TG13065	65	325x176	2,5

## MOD. 1/4

TG14020	20	265x162	0,5
TG14040	40	265x162	1,0
TG14065	65	265x162	1,8

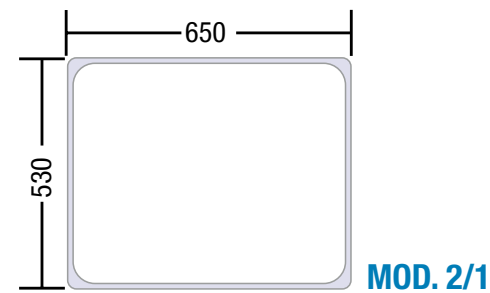

MOD. 2/1

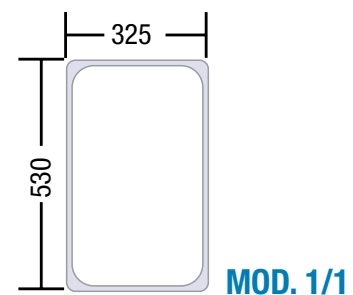

MOD. 1/1

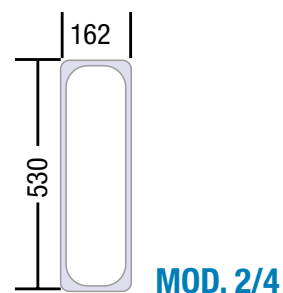

MOD. 2/3

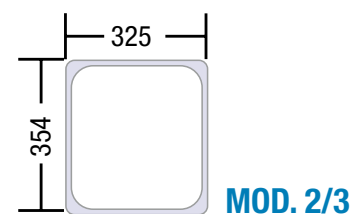

MOD. 1/2

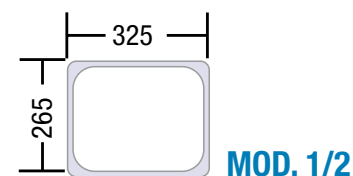

MOD. 1/4

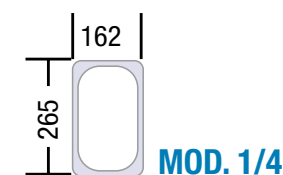
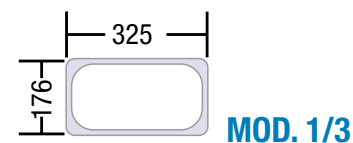

# TEGLIE CON BORDO PIANO

Baking containers with flat edge

CODICE Code	H in mm H in mm	DIM. ESTERNE mm ext. dimens. mm	cap. Lt. cap. lt.
----------------	--------------------	------------------------------------	----------------------

## MOD. 2/1

TL21020	20	650x530	5,0
TL21040	40	650x530	12,4
TL21065	65	650x530	19,0

## MOD. 1/1

TL11010	10	530x325	1,2
TL11020	20	530x325	2,5
TL11040	40	530x325	5,0
TL11065	65	530x325	6,5

## MOD. 2/3

TL23020	20	354x325	1,5
TL23040	40	354x325	3,0
TL23065	65	354x325	5,5

## MOD. 1/2

TL12020	20	325x265	1,0
TL12040	40	325x265	2,0
TL12065	65	325x265	4,0

## MOD. 1/4

TL14020	20	265x162	0,5
TL14040	40	265x162	1,0
TL14065	65	265x162	1,8

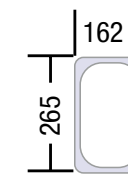
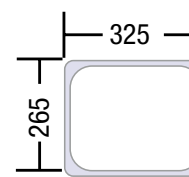
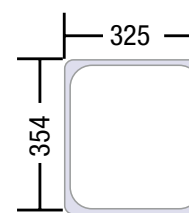
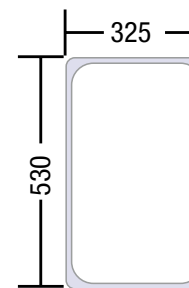
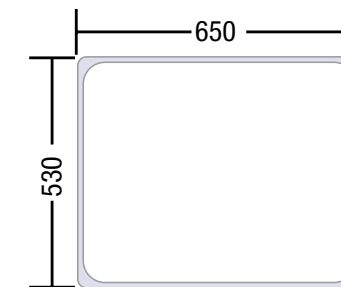

## CONTENITORI GN AISI 304 FORATI SU TUTTI I LATI

*Aisi 304 perforated GN containers*

CODICE Code	H in mm H in mm	DIM. ESTERNE mm ext. dimens. mm	cap. Lt. cap. lt.
----------------	--------------------	------------------------------------	----------------------

### MOD. 2/1

FT21065	65	650x530	20,2
FT21100	100	650x530	31,0
FT21150	150	650x530	46,5
FT21200	200	650x530	62,0

### MOD. 1/1

FT11065	65	530x325	9,8
FT11100	100	530x325	15,0
FT11150	150	530x325	22,5
FT11200	200	530x325	30,0
FT11055	55	530x325	8,4

### MOD. 2/3

FT23065	65	354x325	6,4
FT23100	100	354x325	9,9
FT23150	150	354x325	14,8
FT23200	200	354x325	19,7

### MOD. 1/2

FT12065	65	325x265	4,7
FT12100	100	325x265	7,2
FT12150	150	325x265	10,8
FT12200	200	325x265	14,4

\* FT = Forata sul fondo e sulle pareti / FT = Perforated on bottom and sides

## CONTENITORI GN FORATI SUL FONDO

*Base perforated GN containers*

CODICE Code	H in mm H in mm	DIM. ESTERNE mm ext. dimens. mm	cap. Lt. cap. lt.
----------------	--------------------	------------------------------------	----------------------

### MOD. 2/1

FF21020	20	650x530	5,0
FF21040	40	650x530	12,4
FF21065	65	650x530	19,0

### MOD. 1/1

FF11020	20	530x325	2,5
FF11040	40	530x325	5,0
FF11065	65	530x325	9,0



CODICE Code	H in mm H in mm	DIM. ESTERNE mm ext. dimens. mm	cap. Lt. cap. lt.
----------------	--------------------	------------------------------------	----------------------

### MOD. 2/3

FF23020	20	354x325	1,5
FF23040	40	354x325	3,0
FF23065	65	354x325	5,5

### MOD. 1/2

FF12020	20	325x265	1,0
FF12040	40	325x265	2,0
FF12065	65	325x265	4,0

### MOD. 1/3

FF13020	20	325x176	0,7
FF13040	40	325x176	1,8
FF13065	65	325x176	2,5
FF13100	100	325x175	4,5

### MOD. 2/8

FF28055	55	132x325	1,5
---------	----	---------	-----

\* FF = Forata solo sul fondo / FF = Perforated only on the bottom

## MANIGLIE E SEPARATORI IN ACCIAIO INOX

*SST handles and separator bars*

CODICE Code	Descrizione description
----------------	----------------------------

MARI	Maniglie rientranti / Recessed handles
MAVE	Maniglie verticali / Fixed vertical handles
MASN	Maniglie snodate / Jointed handles
MASC	Maniglie schiacciate / Flat handles

### MOD. 1/2

SEP325	Separatore da 325 mm / Separator bar 325 mm
--------	---

### MOD. 1/1

SEP530	Separatore da 530 mm / Separator bar 530 mm
--------	---

MARI



MAVE



MASN



MASC



1/2

1/1

## COPERCHI IN ACCIAIO

SST lids

### COPERCHI IN ACCIAIO AISI 304

Aisi 304 SST lids

CODICE code	MODELLO model	DIM. ESTERNE mm ext. dimens. mm
C11	1/1	530x325
C24	2/4	530x162
C23	2/3	354x325
C12	1/2	325x265
C13	1/3	325x176
C14	1/4	265x162
C16	1/6	176x162
C19	1/9	176x108

### COPERCHI IN ACCIAIO CON GUARNIZIONE AL SILICONE

SST lids with silicone gasket

CODICE code	MODELLO model	DIM. ESTERNE mm ext. dimens. mm
C11SI	1/1	530x325
C23SI	2/3	354x325
C12SI	1/2	325x265
C13SI	1/3	325x176
C14SI	1/4	265x162
C16SI	1/6	176x162
C19SI	1/9	176x108

### COPERCHI IN ACCIAIO PER COTTURA SOVRAPPOSTA

Chill system cook SST lids

CODICE code	MODELLO model	DIM. ESTERNE mm ext. dimens. mm
C11C	1/1	530x325
C12C	1/2	325x265
C13C	1/3	325x176

### COPERCHI A TENUTA CON VALVOLA

Silicone lids with umbrella

CODICE code	MODELLO model	DIM. ESTERNE mm ext. dimens. mm
C11SIS	1/1	530x325
C12SIS	1/2	325x265
C13SIS	1/3	325x176
C14SIS	1/4	265x162



### COPERCHI A TENUTA S/MANIGLIE

Lids with gasket and notched handles

CODICE code	MODELLO model	DIM. ESTERNE mm ext. dimens. mm
C11SM	1/1	530x325
C23SM	2/3	354x325
C12SM	1/2	325x265
C13SM	1/3	325x176
C14SM	1/4	265x162
C16SM	1/6	176x162

#### CARATTERISTICHE TECNICHE COPERCHI AL SILICONE

Guarnizione resistente fino a 170°C; è consigliato un utilizzo a temperature inferiori per una tenuta maggiore nel tempo

#### SILICON LIDS TECHNICAL FEATURES

Resistant gasket up to 170°C; it is recommended to use them at lower temperatures for a better endurance over time.

### COPERCHI CON SPACCO MANIGLIA

Lids with split for handles

CODICE code	MODELLO model	DIM. ESTERNE mm ext. dimens. mm
C11MA	1/1	530x325
C12MA	1/2	530x162
C13MA	1/3	325x176
C14MA	1/4	265x162
C16MA	1/6	176x162
C23MA	2/3	354x325
C24MA	2/4	530x162

### COPERCHI CON SPACCO MESTOLO

Lids notched for spoon

CODICE code	MODELLO model	DIM. ESTERNE mm ext. dimens. mm
C11ME	1/1	530x325
C12ME	1/2	530x162
C13ME	1/3	325x176
C14ME	1/4	265x162
C16ME	1/6	176x162
C19ME	1/9	176x108
C23ME	2/3	354x325
C24ME	2/4	530x162



## COPERCHI IN ACCIAIO

*Inox lids*

### COPERCHI CON SPACCO MESTOLO E MANIGLIA

*Lids notched for spoon and handles*

CODICE <i>code</i>	MODELLO <i>model</i>	DIM. ESTERNE mm <i>ext. dimens. mm</i>
C11MM	1/1	530x325
C12MM	1/2	530x162
C13MM	1/3	325x176
C14MM	1/4	265x162
C16MM	1/6	176x162
C23MM	2/3	354x325
C24MM	2/4	530x162

### COPERCHI PIATTO

*Flat lids*

CODICE <i>code</i>	MODELLO <i>model</i>	DIM. ESTERNE mm <i>ext. dimens. mm</i>
C11P	1/1	530x325
C12P	1/2	530x162
C13P	1/3	325x176

### FALSI FONDI FORATI

*Insert grids*

CODICE <i>code</i>	MODELLO <i>model</i>	DIM. ESTERNE mm <i>ext. dimens. mm</i>
FFF11	1/1	520x315
FFF12	1/2	520x152
FFF13	1/3	315x166
FFF23	2/3	344x315

### GRIGLIE A FILO

*Wire grids*

CODICE <i>code</i>	DESCRIZIONE <i>description</i>
GG234MM	2/3 int. 4mm, rinf. 5,8mm
GG112MM	1/1 int. 2mm, rinf. 5,8mm
GG113MM	1/1 int. 2,8mm, rinf. 5,8mm
GG212.4MM	2/1 int. 2,4mm, rinf.5,8mm

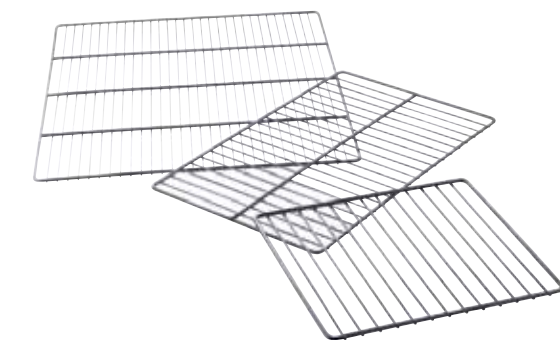

### FRIGGITRICI SENZA MIN/MAX E GANCIO

*Containers for fryer without min/max level and hook*

CODICE <i>code</i>	H in mm <i>h</i>	DIM. ESTERNE MM <i>ext. dimens. mm</i>	cap. Lt. <i>cap. Lt.</i>
F23200	200	345x320	19,7
F12150	150	320x259	10,8
F12200	200	320x259	14,4
F13150	150	320x172	6,8
F13200	200	320x172	9,0

### CONTENITORE BAGNOMARIA

*Bain-Marie container*

CODICE <i>code</i>	H in mm <i>h</i>	DIM. ESTERNE MM <i>ext. dimens. mm</i>
11163	163	530x325

## BACINELLE GASTRONORM SMALTATE ANTIADERENTI

*Gastronorm nonstick enameled trays*

CODICE <i>code</i>	H in mm <i>h</i>	DIM. ESTERNE MM <i>ext. dimens. mm</i>	cap. Lt. <i>cap. Lt.</i>
TS11020	20	530x325	2,5
TS11040	40	530x325	5,0
TS11065	65	530x325	9,0

### MOD. 1/2

TS12040	40	325x265	2,0
TS12065	65	325x265	4,0

### MOD. 1/3

TS13040	40	325x176	1,8
TS13065	65	325x176	2,5





## CONTENITORI GASTRONORM IN POLIPROPILENE

*Polypropylene gastronorm containers*

### CONTENITORI IN POLIPROPILENE IMPILABILI

*Stackable polypropylene gastronorm containers*

CODICE code	H in mm h	DIM. ESTERNE MM ext. dimens. mm	cap. Lt. cap. Lt.
----------------	--------------	------------------------------------	----------------------

#### MOD. 1/1

PR11065	65	530X325	9,5
PR11100	100	530X325	13,0
PR11150	150	530X325	19,5
PR11200	200	530X325	26,0

#### MOD. 1/2

PR12065	65	325X265	3,9
PR12100	100	325X265	5,9
PR12150	150	325X265	8,9
PR12200	200	325X265	11,8

#### MOD. 2/1

PR21150	150	650x530	46,5
PR21200	200	650x530	62,0

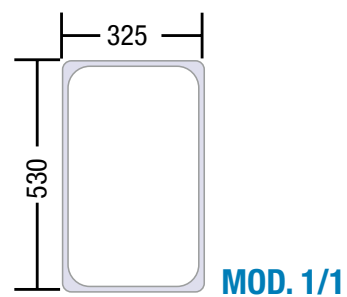

MOD. 1/1

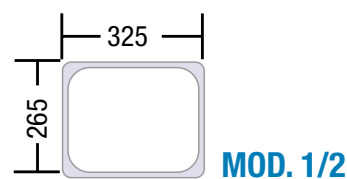

MOD. 1/2

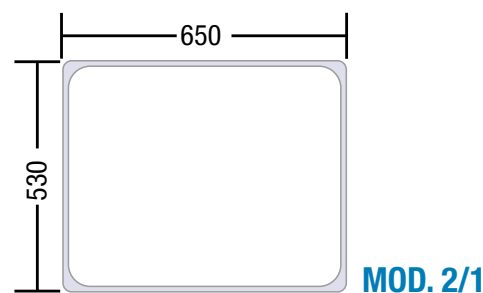

MOD. 2/1

16

MOD. 1/3

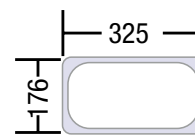

MOD. 1/4

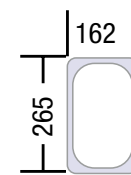

MOD. 1/6

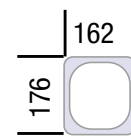

MOD. 1/9

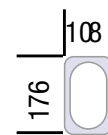

17



### CONTENITORI IN POLIPROPILENE IMPILABILI

*Stackable polypropylene gastronorm containers*

CODICE code	H in mm h	DIM. ESTERNE MM ext. dimens. mm	cap. Lt. cap. Lt.
----------------	--------------	------------------------------------	----------------------

#### MOD. 1/3

PR13065	65	325X176	2,4
PR13100	100	325X176	3,6
PR13150	150	325X176	5,3
PR13200	200	325X176	7,0

#### MOD. 1/4

PR14065	65	265X162	1,7
PR14100	100	265X162	2,5
PR14150	150	265X162	3,7
PR14200	200	265X162	5,5

#### MOD. 1/6

PR16065	65	176X162	1,0
PR16100	100	176X162	1,5
PR16150	150	176X162	2,2
PR16200	200	176X162	3,4

#### MOD. 1/9

PR19065	65	176X108	0,6
PR19100	100	176X108	1,0

#### CARATTERISTICHE TECNICHE GASTRONORM IN POLIPROPILENE

Impilabili - Ideali per il trasporto  
Coperchi ermetici per una perfetta chiusura  
Lavabili in lavastoviglie  
Utilizzabili nel microonde  
Temperature raccomandate da -40°C a +70°C  
NECESSITATE DI UN COLORE PARTICOLARE? CONTATTATECI PER UN'OFFERTA!

#### POLYPROPYLENE GASTRONORM TECHNICAL FEATURES

Stackable - Perfect for transport.  
Hermetic lids for an excellent closing.  
Dishwasher safe.  
Microwave safe.  
Recommended temperatures: from -40°C to +70°C.  
DO YOU NEED A SPECIFIC COLOUR? CONTACT US FOR AN OFFER!

### FALSI FONDI FORATI IN PP

*Polypropylene insert grids*

CODICE code	MODELLO model	DIM. ESTERNE MM ext. dimens. mm
----------------	------------------	------------------------------------

PRFFF11	1/1	520X315
PRFFF12	1/2	320X152
PRFFF13	1/3	315X166
PRFFF14	1/4	255X152
PRFFF16	1/6	166X152

# COPERCHI IN PP

PP lids

## COPERCHI IN PP ERMETICI COLORATI

Polypropylene hermetic lids

### MOD. 2/1

PRC21 2/1 Trasparente / Clear

### MOD. 1/1

PRC11	1/1	BLU / Blue	
PRCR011	1/1	ROSSO / Red	
PRCGI11	1/1	GIALLO / Yellow	
PRCVE11	1/1	VERDE / Green	
PRCBI11	1/1	BIANCO / White	
PRCTR11	1/1	Trasparente / Clear	

### MOD. 1/2

PRC12	1/2	BLU / Blue	
PRCR012	1/2	ROSSO / Red	
PRCGI12	1/2	GIALLO / Yellow	
PRCVE12	1/2	VERDE / Green	
PRCBI12	1/2	BIANCO / White	
PRCTR12	1/2	Trasparente / Clear	

### MOD. 1/3

PRC13	1/3	BLU / Blue	
PRCR013	1/3	ROSSO / Red	
PRCGI13	1/3	GIALLO / Yellow	
PRCVE13	1/3	VERDE / Green	
PRCBI13	1/3	BIANCO / White	
PRCTR13	1/3	Trasparente / Clear	

### MOD. 1/4

PRC14	1/4	BLU / Blue	
PRCR014	1/4	ROSSO / Red	
PRCGI14	1/4	GIALLO / Yellow	
PRCVE14	1/4	VERDE / Green	
PRCBI14	1/4	BIANCO / White	
PRCTR14	1/4	Trasparente / Clear	

### MOD. 1/6

PRC16	1/6	BLU / Blue	
PRCR016	1/6	ROSSO / Red	
PRCGI16	1/6	GIALLO / Yellow	
PRCVE16	1/6	VERDE / Green	
PRCBI16	1/6	BIANCO / White	
PRCTR16	1/6	Trasparente / Clear	

### MOD. 1/9

PRC19	1/9	BLU / Blue	
PRCR019	1/9	ROSSO / Red	
PRCGI19	1/9	GIALLO / Yellow	
PRCVE19	1/9	VERDE / Green	
PRCBI19	1/9	BIANCO / White	
PRCTR19	1/9	Trasparente / Clear	



## CONTENITORI GASTRONORM IN POLICARBONATO

Polycarbonate  
Gastronorm containers

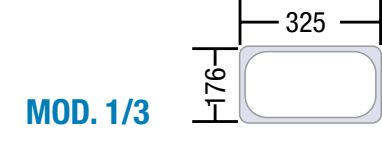
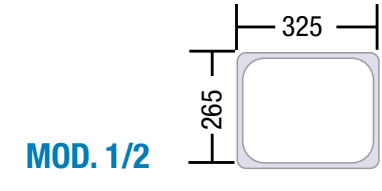
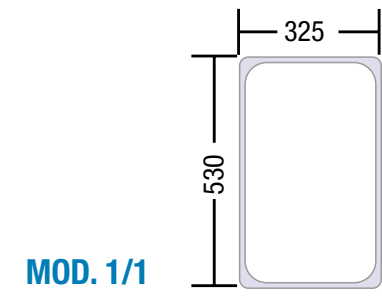
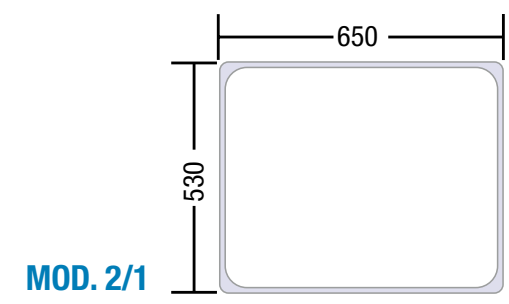

CODICE code	H in mm h	DIM. ESTERNE MM ext. dimens. mm	cap. Lt. cap. Lt.
-------------	-----------	---------------------------------	-------------------

MOD. 2/1			
P21150	150	650x530	46,5
P21200	200	650x530	62,0

MOD. 1/1			
P11065	65	530x325	8,5
P11100	100	530x325	13,0
P11150	150	530x325	19,5
P11200	200	530x325	26,0

MOD. 1/2			
P12065	65	325x265	3,9
P12100	100	325x265	5,9
P12150	150	325x265	8,9
P12200	200	325x265	11,8

MOD. 1/3			
P13065	65	325x176	2,4
P13100	100	325x176	3,6
P13150	150	325x176	5,3
P13200	200	325x176	7,0

# CONTENITORI GASTRONORM IN POLICARBONATO

Polycarbonate Gastronorm containers

CODICE code	H in mm h	DIM. ESTERNE MM ext. dimens. mm	cap. Lt. cap. Lt.
----------------	--------------	------------------------------------	----------------------

## MOD. 1/4

P14065	65	265x162	1,7
P14100	100	265x162	2,5
P14150	150	265x162	3,7
P14200	200	265x162	5,5

## MOD. 1/6

P16065	65	176x162	1,0
P16100	100	176x162	1,5
P16150	150	176x162	2,2
P16200	200	176x162	3,4

## MOD. 1/9

P19065	65	176x108	0,6
P19100	100	176x108	1,0

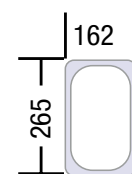

MOD. 1/4

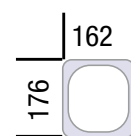

MOD. 1/6



MOD. 1/9



## COPERCHI PIATTO IN PC CON MANIGLIE LATERALI Flat pc lids with lateral handles

CODICE code	DIM dim	DIM. ESTERNE MM ext. dimens. mm
PC13C	1/3	325x176

## COPERCHI PC A TENUTA CON GUARNIZIONE IN GOMMA Polycarbonate flat lids with rubber seal

CODICE code	DIM dim	DIM. ESTERNE MM ext. dimens. mm
PC11SI	1/1	530x325
PC12SI	1/2	325x265
PC16SI	1/6	176x162



# COPERCHI Lids

## COPERCHI IN POLICARBONATO Polycarbonate lids

CODICE code	DIM dim	DIM. ESTERNE MM ext. dimens. mm
PC21	2/1	650x530
PC11	1/1	530x325
PC12	1/2	325x265
PC13	1/3	325x176
PC14	1/4	265x162
PC16	1/6	176x162
PC19	1/9	176x108

PC13GS	1/3	331x182x75
--------	-----	------------

## COPERCHI PIATTI IN PC SOVRAPPONIBILI Polycarbonate flat lids

CODICE code	DIM dim	DIM. ESTERNE MM ext. dimens. mm
PC11P	1/1	530x325
PC12P	1/2	325x265
PC13P	1/3	325x176
PC14P	1/4	325x176
PC16P	1/6	325x176



## COPERCHI IN PC CON SPACCO MESTOLO Polycarbonate lids notched for spoon

CODICE code	DIM dim	DIM. ESTERNE MM ext. dimens. mm
PC11ME	1/1	-
PC12ME	1/2	-
PC13ME	1/3	-
PC14ME	1/4	-
PC16ME	1/6	-

## FALSI FONDI FORATI IN PC Polycarbonate insert grids

CODICE code	DIM dim	DIM. ESTERNE MM ext. dimens. mm
PFFF21	2/1	640x520
PFFF11	1/1	520x315
PFFF12	1/2	320x152
PFFF13	1/3	315x166
PFFF14	1/4	255x152
PFFF16	1/6	166x152



# CONTENITORI NERI GASTRONORM IN POLICARBONATO

Black polycarbonate Gastronorm containers

CODICE code	H in mm h	COLORE Colour	cap. Lt. cap. Lt.
----------------	--------------	------------------	----------------------

## MOD. 1/1

P11065N	65	Nero / Black	8,5
P11100N	100	Nero / Black	13,0
P11150N	150	Nero / Black	19,5
P11200N	200	Nero / Black	26,0

## MOD. 1/2

P12065N	65	Nero / Black	3,9
P12100N	100	Nero / Black	5,9
P12150N	150	Nero / Black	8,9
P12200N	200	Nero / Black	11,8

## MOD. 1/3

P13065N	65	Nero / Black	2,4
P13100N	100	Nero / Black	3,6
P13150N	150	Nero / Black	5,3
P13200N	200	Nero / Black	7,0

## MOD. 1/4

P14065N	65	Nero / Black	17,0
P14100N	100	Nero / Black	2,5
P14150N	150	Nero / Black	3,7

## MOD. 1/6

P16065N	65	Nero / Black	1,0
P16100N	100	Nero / Black	1,5
P16150N	150	Nero / Black	2,2

## MOD. 1/9

P19065N	65	Nero / Black	0,6
P19100N	100	Nero / Black	1,0

Un gradino permette d'impilare e separare senza fatica le bacinelle; i nostri contenitori Gastronorm in polycarbonato sono compatibili con quelli in acciaio.

*The stacking collar let you stack and separate these containers with ease; our GN polycarbonate containers are compatible with our stainless steel GN line.*

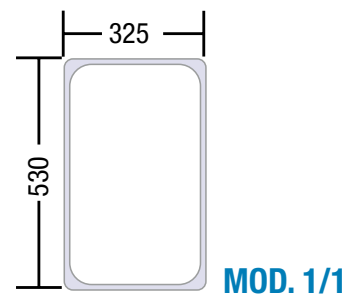

MOD. 1/1

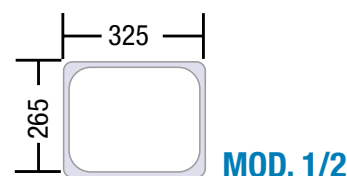

MOD. 1/2

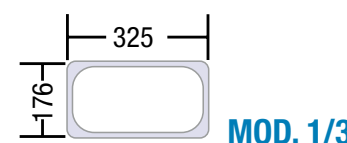

MOD. 1/3

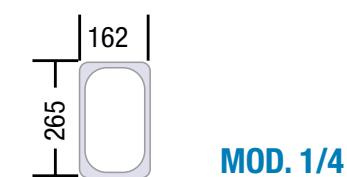

MOD. 1/4

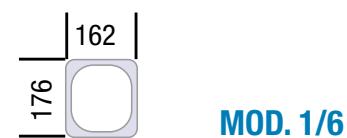

MOD. 1/6



MOD. 1/9

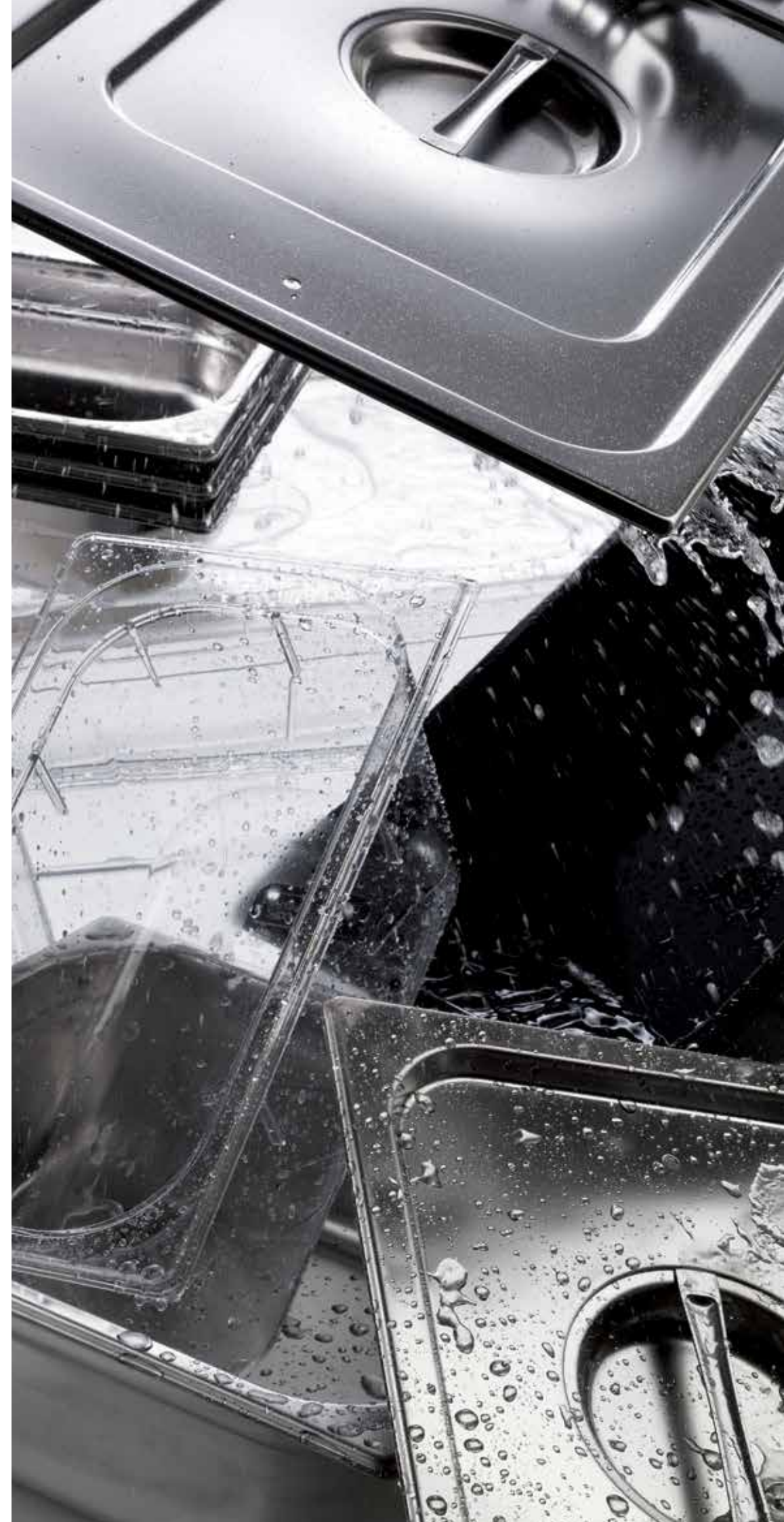



## BACINELLE GELATO

*Ice cream basins*

La paletta disegna morbide piste gelate...  
nell'igiene assoluta dell'acciaio migliore...

Brrrr... che buono!!!

*The spoon carves soft icy slopes  
in the best steel hygiene...*

Brrrr... that good!

Utilizzate per l'esposizione del gelato nelle vetrine refrigeranti, sono prodotte in acciaio inossidabile AISI304 per garantire un'alta qualità e igienicità. Disponibili in ogni modello e misura e dotate di accessori, come spatole dalla maniglia colorata e coperchi trasparenti.

*These stainless steel containers, manufactured in AISI 304 to ensure the best quality and hygiene, are used in icecream parlours to display the product. Available in every model and size and equipped with accessories, like spatulas with coloured handles and transparent lids.*

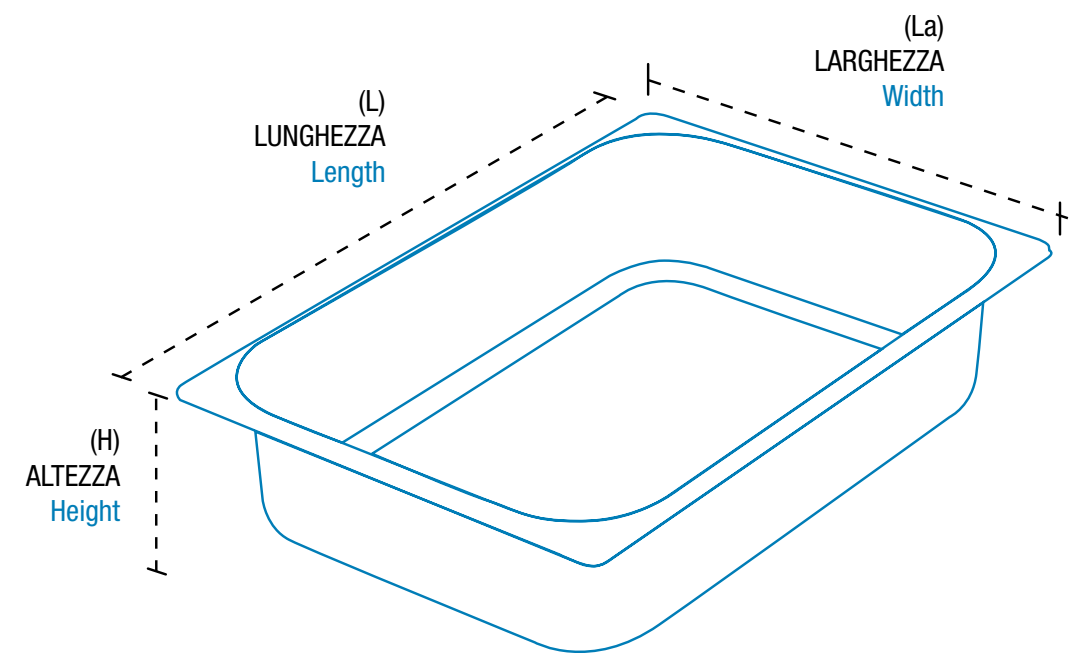



## BACINELLE GELATO

Ice cream containers

CODICE Code	H in mm H in mm	DIM. ESTERNE mm Ext. dimens. in mm	cap. Lt. cap.Lt.
G2180	80	210x200	2,0
G2112	120	210x200	4,0
G2115	150	210x200	4,6
G2117	170	210x200	5,2
G2120	200	210x200	6,2

G2612	120	260x165	3,5
G2615	150	260x165	4,1
G2617	170	260x165	4,7

G3308	80	330x165	3,5
G3312	120	330x165	5,0
G3315	150	330x165	6,5
G3317	170	330x165	7,7
G3318	180	330x165	8,0
G3320	200	330x165	9,7

G3608	80	360x165	3,8
G3612	120	360x165	5,4
G3615	150	360x165	7,1
G3617	170	360x165	8,4
G3618	180	360x165	8,8

G3604A	40	360x250	2,4
G3308A	80	330x250	5,0
G3312A	120	330x250	8,0
G3315A	150	330x250	10,8
G3318A	180	330x250	12,6
G3320A	200	330x250	14,0

G3608A	80	360x250	5,0
G3612A	120	360x250	8,0
G3615A	150	360x250	10,8
G3618A	180	360x250	12,6

G4215	150	420x200	9,7
G4217	170	420x200	10,6
G4220	200	420x200	13,5
G4225	250	420x200	18,0



## LAVAPORZIONATORE COMPLETO

Container for ice cream scoops

CODICE Code	H in mm H in mm	DIM. ESTERNE mm Ext. dimens. in mm	cap. Lt. cap.Lt.
GLAV	120	270x110	2,5

## BACINELLA GELATO "CARAPINA"

Round ice cream pan

CODICE Code	H in mm H in mm	DIM. ESTERNE mm Ext. dimens. in mm	cap. Lt. cap.Lt.
G2025	250	200	7,3

## SPATOLE GELATO CON MANICO IN SAN-KOSTIL

Ice cream spatula with san-kostil handle

CODICE Code	DIM. mm dim. mm	COLORE colour
SPA26TR	265	Trasparente / Clear
SPA26AR	265	Arancio / Orange
SPA26RO	265	Rosso / Red
SPA26BL	265	Blu / Blue
SPA26VE	265	Verde / Green

## COPERCHI IN PLASTICA

Plastic lids for ice cream containers

CODICE Code	DIM. ESTERNE mm ext. dimens. mm	COLORE colour
GC2120	210x200	Trasparente / Clear
GC26516	265x160	Trasparente / Clear
GC33165	330x165	Trasparente / Clear
GC36165	360x165	Trasparente / Clear



## GELATERIA IN POLICARBONATO

Polycarbonate ice cream lids and containers

### BACINELLE GELATO IN POLICARBONATO

Polycarbonate ice cream containers

CODICE Code	H in mm H in mm	DIM. ESTERNE mm Ext. dims. in mm	cap. Lt. cap.Lt.
PG3612	120	360x165	5,4
PG3608A	80	360x250	5,0
PG3612A	120	360x250	8,0

### COPERCHIO IN POLICARBONATO PIATTO

Flat polycarbonate ice cream lid

CODICE Code	H in mm H in mm	DIM. ESTERNE mm Ext. dims. in mm	cap. Lt. cap.Lt.
GC36165PT	-	360x165	-

### COPERCHI IN POLICARBONATO BOMBATI

Curved polycarbonate ice cream lid

CODICE Code	H in mm H in mm	DIM. ESTERNE mm Ext. dims. in mm	cap. Lt. cap.Lt.
GC36250B	76	360x250	-
GC36165B	76	360x165	-







## VASSOI E CONTENITORI

### Trays and containers

Belli e dall'igiene assoluta, presentano con stile e rigorosità il prodotto. Incarnano il top della qualità ma cavalcano anche... l'onda del look.

*Beautiful and perfectly hygienic. They have both style and a definite design. They embody top quality but also... ride the crest of the wave.*

Forse la gamma di articoli più curata dal punto di vista del design, è studiata per arredare al meglio pasticcerie e macellerie dando un tocco di classe a vetrine e laboratori. Eccezionale la qualità delle finiture (spazzolatura a mano). Disponibili in diversi modelli, forme e misure per soddisfare al meglio ogni esigenza di spazio e di look, sono realizzati con i migliori materiali, per garantire igiene assoluta.

*This range of articles is designed with bakeries and butcher shops in mind, in order to give a touch of class to showcases and workshops.*

*The quality of the finishes is exceptional (they are hand polished). Available in different designs, shapes and sizes to meet everyday demands of space and look, they are made with the best materials, to ensure absolute cleanliness.*

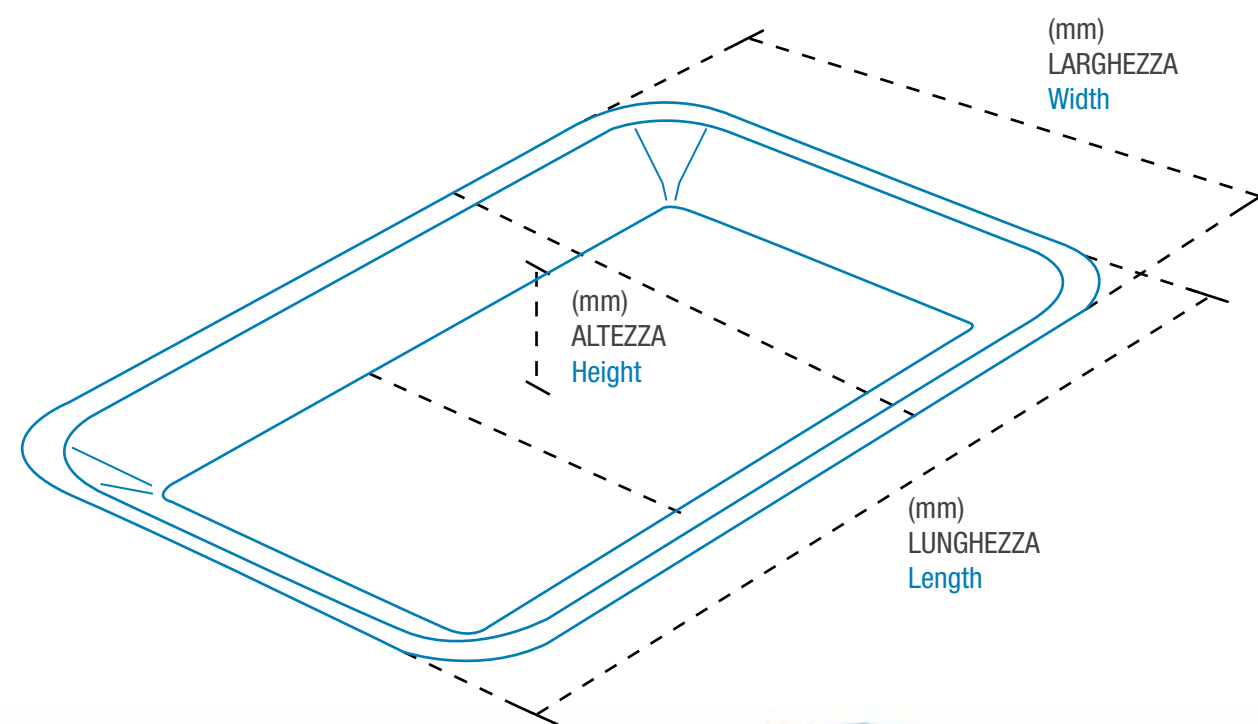

## VASSOIO INOX SPIGOLATO

Standard trays

CODICE Code	DIM. ESTERNE mm ext. dimens. in mm	H in mm H in mm
087056	290x210	15
087055	400x300	15
087054	580x210	15
087053	730x210	15
087052	730x250	15
087051	830x270	15

## VASSOIO INOX BORDI ARROTONDATI

Trays with rounded corners

CODICE Code	DIM. ESTERNE mm ext. dimens. in mm	H in mm H in mm
085053	260x230	20
085052	340x210	20
085051	450x250	24

## VASSOIO INOX BORDI ARROTONDATI

Trays with rounded corners

CODICE Code	DIM. ESTERNE mm ext. dimens. in mm	H in mm H in mm
087057	300x210	10

## RECIPIENTE INOX MOD. FRANCIA

Container 450x190x35

CODICE Code	DIM. ESTERNE mm ext. dimens. in mm	H in mm H in mm
086051	450x190x35	35



## CONTENITORI PER SUPERMERCATI E CARRELLI

Containers for supermarkets and trolleys

CODICE Code	DIM. ESTERNE mm ext. dimens. in mm	H in mm H in mm
090053	610x405x35	35
090052	610x405x55	55
090051	610x405x75	75

## CONTENITORE STANDARD

Standard container

CODICE Code	DIM. ESTERNE mm ext. dimens. in mm	H in mm H in mm
088057	244x216x55	55
088056	320x230x55	55
088055	350x240x55	55
088054	410x310x55	55
088053	410x310x75	75
088052	500x350x55	55
088051	500x350x75	75

## GRIGLIA PER CONTENITORE

Grids for standard containers

CODICE Code	DIM. ESTERNE mm ext. dimens. in mm	Per contenitore For container
089056	200x175	244x216x55
089055	270x180	320x230x55
089054	296x186	350x240x55
089053	360x260	410x310x55/75
089052	445x300	500x350x55/75

## RACCOGLITORE

Container 244x230x42

CODICE Code	DIM. ESTERNE mm ext. dimens. in mm	H in mm H in mm
092053	260x230x42	42



## CONTENITORI PER PIZZA E ALIMENTI

Containers for foods and pizza

### CONT. IN POLIETILENE COI LATI CHIUSI 600x400mm

Polyethylene containers 600x400mm with closed sides

CODICE code	DIM. ESTERNE mm ext. dimens. mm	DIM. INTERNE mm int. dimens. mm	Cap. Lt. cap. lt.
PE60407	600x400x75	565x365x70	14
PE60409	600x400x95	565x365x90	18
PE604013	600x400x130	565x365x120	24

### COPERCHIO IN POLIETILENE SENZA MANIGLIE 600x400mm

Polyethylene white lid for 600x400mm without handle

CODICE code	DIM. ESTERNE mm ext. dimens. mm
PEC6040	600x400

### CONT. IN POLIPROPILENE CON MANIGLIE ESTERNE 630x430mm

Polypropylene containers 630x430mm with external handles

CODICE code	DIM. ESTERNE mm ext. dimens. mm	DIM. INTERNE mm int. dimens. mm	Cap. Lt. cap. lt.
PR63436	630x430x65 h	600x400x60 h	14
PR63438	630x430x85 h	600x400x80 h	19
PR634311	630x430x115 h	600x400x110 h	26

### COPERCHIO IN POLIPROPILENE 630x430mm

Polypropylene white lid for 630x430mm with handle

CODICE code	DIM. ESTERNE mm ext. dimens. mm
PRC6343	640x435



## ARTICOLI PER LA TAVOLA *Tableware*

Dopo un brindisi possiamo anche buttarli alle nostre spalle... sono pronti a ogni impatto! Bellezza... in sicurezza: una vittoria importante!

*After making a toast we can throw them behind us... they're ready for any impact! Beauty in safety: a major victory!*



\* DISPONIBILI CARRELLI PER CONTENITORI PIZZA 60x40  
NELLA LISTA CARRELLI.

*Trolleys for polypropylene containers 60x40 available in  
the trolleys list.*

## BROCCHE

Pitchers

### BROCCA IN PC NON IMPILABILE

Polycarbonate not stackable pitcher

CODICE code	COLORE colour	Cap. Lt. cap. lt.	DIM. mm dim. mm
PBR015	Trasp. / Clear	1,5	Ø 120 x 170 H



### BROCCA IN POLICARBONATO TRASPARENTE IMPILABILE

Transparent polycarbonate stackable pitcher

CODICE code	COLORE colour	Cap. Lt. cap. lt.	DIM. mm dim. mm
PBI1	Trasp. / Clear	1	Ø 125x175 H
PBI12	Trasp. / Clear	1,2	Ø 128x186 H
PBI15	Trasp. / Clear	1,5	Ø 135x200 H



### BROCCA IN POLICARBONATO BLU IMPILABILE

Blue polycarbonate stackable pitcher

CODICE code	COLORE colour	Cap. Lt. cap. lt.	DIM. mm dim. mm
PBI1B	Blu / Blue	1	Ø 125x175 H
PBI12B	Blu / Blue	1,2	Ø 128x186 H
PBI15B	Blu / Blue	1,5	Ø 135x200 H



### BROCCA IN POLICARBONATO ARANCIO IMPILABILE

Orange polycarbonate stackable pitcher

CODICE code	COLORE colour	Cap. Lt. cap. lt.	DIM. mm dim. mm
PBI1A	Arancio / Orange	1	Ø 125x175 H
PBI12A	Arancio / Orange	1,2	Ø 128x186 H
PBI15A	Arancio / Orange	1,5	Ø 135x200 H



### BROCCA IN POLIPROPILENE IMPILABILE

Polypropylene stackable pitcher

CODICE code	COLORE colour	Cap. Lt. cap. lt.	DIM. mm dim. mm
PRB1	Trasp. / Clear	1	Ø 125x175 H
PRB12	Trasp. / Clear	1,2	Ø 128x186 H
PRB15	Trasp. / Clear	1,5	Ø 135x200 H



### COPERCHIO IN PP PER BROCCA

Polypropylene lid for stackable pitchers

CODICE code	COLORE colour	Cap. Lt. cap. lt.	DIM. mm dim. mm
PRCBROCCA1	Bianco / White	1	Ø 125
PRCBR12	Bianco / White	1,2	Ø 128
PRCBROCCA15	Bianco / White	1,5	Ø 135



## BICCHIERI

Glasses

### BICCHIERE IN PC LONG DRINK

Polycarbonate long-drink glass

CODICE code	COLORE colour	Cap. cl. cap. cl.	DIM. mm dim. mm
PBLD	Trasp. / Clear	25	Ø 60x145



### BICCHIERE IN SAN GRANITY

San kostil granity glass

CODICE code	COLORE colour	Cap. cl. cap. cl.	DIM. mm dim. mm
SBTCL35	Trasp. / Clear	35	Ø 85x97
SBTCL38	Trasp. / Clear	38	Ø 80x130



## BICCHIERI

Glasses

### BICCHIERE IN PC GRANITY

Polycarbonate granity glass

CODICE code	COLORE colour	Cap. cl. cap. cl.	DIM. mm dim. mm
PBTCL35	Trasp. / Clear	35	Ø 85x97
PBTCL38	Trasp. / Clear	38	Ø 80x130

### BICCHIERI IN SAN "TUMBLER"

SAN tumbler glasses

CODICE code	COLORE colour	Cap. cl. cap. cl.	DIM. mm dim. mm
SBPPT	Trasp. / Clear	15	Ø 57x90
SBPPB	Blu / Blue	15	Ø 57x90
SBPPA	Arancio / Orange	15	Ø 57x90
SBPPV	Verde / Green	15	Ø 57x90
SBPPR	Rosso / Red	15	Ø 57x90
SBPJT	Trasp. / Clear	20	Ø 65x100
SBPJR	Rosso / Red	20	Ø 65x100
SBPT	Trasp. / Clear	28	Ø 70x110
SBPB	Blu / Blue	28	Ø 70x110
SBPA	Arancio / Orange	28	Ø 70x110
SBPV	Verde / Green	28	Ø 70x110
SBMT	Trasp. / Clear	36	Ø 75x130
SBMB	Blu / Blue	36	Ø 75x130
SBMA	Arancio / Orange	36	Ø 75x130
SBMV	Verde / Green	36	Ø 75x130
SBGT	Trasp. / Clear	47	Ø 80x145
SBGB	Blu / Blue	47	Ø 80x145
SBGA	Arancio / Orange	47	Ø 80x145
SBGV	Verde / Green	47	Ø 80x145

### BICCHIERE IN POLICARBONATO "WHISKY"

Polycarbonate "whiskey" glasses

CODICE code	COLORE colour	Cap. cl. cap. cl.	DIM. mm dim. mm
PBW	Trasp. / Clear	29	59X15



38

## VASSOI PER FAST FOOD IN POLIPROPILENE IN DIVERSI COLORI

Polypropylene fast food trays  
in different colours

### VASSOIO PICCOLO IN PP 365x270

Polypropylene little tray 365x270

CODICE code	COLORE colour	MIS. EST ext. meas.	MIS. INT int. meas.
PRFFPB	Beige / Beige	365x270	315x235
PRFFPGC	Grigio chiaro / Light grey	365x270	315x235
PRFFPG	Grigio scuro / Dark grey	365x270	315x235
PRFFPM	Marrone / Brown	365x270	315x235
PRFFPA	Arancio / Orange	365x270	315x235
PRFFPV	Verde / Green	365x270	315x235

Tutti i vassoi in PP hanno una superficie antiscivolo, sono resistenti ai graffi e lavabili in lavastoviglie.

All polypropylene trays have a skidproof surface; they are scratch resistant and dishwasher safe.

### VASSOIO MEDIO IN PP 435x310

Polypropylene medium tray 435x310

CODICE code	COLORE colour	MIS. EST ext. meas.	MIS. INT int. meas.
PRFFMBE	Beige / Beige	435x310	385x275
PRFFMGC	Grigio chiaro / Light grey	435x310	385x275
PRFFMG	Grigio scuro / Dark grey	435x310	385x275
PRFFMM	Marrone / Brown	435x310	385x275
PRFFMA	Arancio / Orange	435x310	385x275
PRFFMV	Verde / Green	435x310	385x275

### VASSOIO GRANDE IN PP 475x355

Polypropylene medium tray 475x355

CODICE code	COLORE colour	MIS. EST ext. meas.	MIS. INT int. meas.
PRFFGBE	Beige / Beige	475X355	415X320
PRFFGGC	Grigio chiaro / Light grey	475X355	415X320
PRFFGG	Grigio scuro / Dark grey	475X355	415X320
PRFFGM	Marrone / Brown	475X355	415X320
PRFFGA	Arancio / Orange	475X355	415X320
PRFFGV	Verde / Green	475X355	415X320

### VASSOIO MEDIO IN PP 440x310 CON MANIGLIE

Polypropylene medium tray 440x310 with handles

CODICE code	COLORE colour	MIS. EST ext. meas.	MIS. INT int. meas.
PRFFMMG	Grigio / Grey	440x310	365x285
PRFFMMB	Blu / Blue	440x310	365x285
PRFFMMM	Marrone / Brown	440x310	365x285



39



## VASSOI IN POLICARBONATO

Polycarbonate trays

### VASSOI 290x195 IN POLICARBONATO

Polycarbonate trays 290x195

CODICE code	COLORE colour	MIS. EST ext. meas.
P29195B	Trasparente / Transparent	290x195
P29195N	Nero / Black	290x195

### VASSOI 580x195 IN POLICARBONATO

Polycarbonate trays 580x195

CODICE code	COLORE colour	MIS. EST ext. meas.
P58195	Trasparente / Transparent	580x195
P58195N	Nero / Black	580x195

### VASSOI 350x280 IN POLICARBONATO

Polycarbonate trays 350x280

CODICE code	COLORE colour	MIS. EST ext. meas.	MIS. INT int. meas.
P3427	Trasparente / Transparent	350x280x15	349x278x15
P3427N	Nero / Black	350x280x15	349x278x15
P3427bianco	Bianco / White	350x280x15	349x278x15

### VASSOI 400x200 IN POLICARBONATO

Polycarbonate trays 400x200

CODICE code	COLORE colour	MIS. EST ext. meas.	MIS. INT int. meas.
P3919	Trasparente / Transparent	400x200x15	395x195x15
P3919N	Nero / Black	400x200x15	395x195x15

\*Minimo d'ordine 1000 pz

### VASSOI 400x300 IN POLICARBONATO

Polycarbonate trays 400x300

CODICE code	COLORE colour	MIS. EST ext. meas.	MIS. INT int. meas.
P3040	Trasparente / Transparent	400x300x15	395x195x15
P3040N	Nero / Black	400x300x15	395x195x15

\*Minimo d'ordine 1000pz



## PIATTI, COPRIPIATTI INSALATIERE

Plates, Plate-covers, Salad bowls

### PIATTI FONDI IN POLICARBONATO

Polycarbonate soup plates

CODICE code	COLORE colour	DIAMETRO in mm diameter in mm
PCF21	Bianco / White	210
PCF23	Bianco / White	230

### PIATTI PIANI IN POLICARBONATO

Polycarbonate flat plates

CODICE code	COLORE colour	DIAMETRO in mm diameter in mm
PCPBP	Bianco / White	208
PCPBM	Bianco / White	228
PCPBG	Bianco / White	252

## INSALATIERE

Salad bowls

### INSALATIERE IN POLICARBONATO

Polycarbonate salad bowls

CODICE code	COLORE colour	DIM. EST. ext. dim.	CAP. LT cap. lt
PCI15	Trasparente / Transparent	Ø 15	0,57
PCI20	Trasparente / Transparent	Ø 20	1,3
PCI25	Trasparente / Transparent	Ø 25	2,6
PCI30	Trasparente / Transparent	Ø 30	5,0
PCI39	Trasparente / Transparent	Ø 39	9,05

CODICE code	COLORE colour	DIM. EST. ext. dim.	CAP. LT cap. lt
PCI25VE	Verde / Green	Ø 25	2,6
PCI30VE	Verde / Green	Ø 30	5,0
PCI25AR	Arancio / Orange	Ø 25	2,6
PCI30AR	Arancio / Orange	Ø 30	5,0

## COPRIPIATTI IN PC

Polycarbonate plate-covers

### COPRIPIATTO Ø22 CON MANIGLIA

Plate-covers Ø22 with handle

CODICE code	COLORE colour	DIM. ESTERNE ed INTERNE external and internal dim.
PC22TM	Trasparente / Transparent	220-214 mm
PC22ROM	Rosso / Red	220-214 mm



### COPRIPIATTO Ø 24 CON MANIGLIA

Plate-covers Ø24 with handle

CODICE code	COLORE colour	DIM. ESTERNE ed INTERNE external and internal dim.
PC24TM	Trasparente / Transparent	240-233 mm
PC24BIM	Bianco / White	240-233 mm
PC24ROM	Rosso / Red	240-233 mm



### COPRIPIATTO Ø 24 SENZA MANIGLIA

Plate-covers Ø24 without handle

CODICE code	COLORE colour	DIM. ESTERNE ed INTERNE external and internal dim.
PCAT	Trasparente / Transparent	240 h 38 mm
PCAB	Bianco / White	240 h 38 mm
PCAR	Rosso / Red	240 h 38 mm
PCAG	Fumé / Smoky grey	240 h 38 mm



### COPRIPIATTO CON FORO CENTRALE

Plate-covers with central hole

CODICE code	COLORE colour	DIM. ESTERNE ed INTERNE external and internal dim.
<b>Ø 22</b>		
PC22TF	Trasparente / Transparent	220-215 mm
<b>Ø 24</b>		
PC24TF	Trasparente / Transparent	238-240 mm
<b>Ø 26</b>		
PC26TF	Trasparente / Transparent	265-243 mm
<b>Ø 27</b>		
PC27TF	Trasparente / Transparent	270-275 mm
<b>Ø 28</b>		
PC28TF	Trasparente / Transparent	280-285 mm



### COPRIPIATTO BIUSO Ø 24 E 28

Plate-covers Ø24 and 28

CODICE code	COLORE colour	DIM. ESTERNE ed INTERNE external and internal dim.
PC2428TF	Trasparente / Transparent	280-285 mm

### COPRIPIATTO OVALE 31,5X29

Oval plate-covers 31,5x29

CODICE code	COLORE colour	DIM. ESTERNE ed INTERNE external and internal dim.
PC33TFOV	Trasparente / Transparent	330-325 mm

### PORTAPOSATE A 4 SCOMPARTI CON COPERCHIO

Rack for cutlery with 4 compartments

CODICE code	COLORE colour	SCOMPARTI compartments	DIM. SCOMPARTI dim. compartments
RCEST04	Grigio / Grey	4	530x325x100
RCEST04B	Blu / Blue	4	530x325x100

### COPERCHIO BIANCO SOVRAPPONIBILE

PER PORTAPOSATE A 4 SCOMPARTI

Stackable transparent lid for cutlery box with 4 compartments

CODICE code	DIM. IN MM dim. in mm
RCOP4	530x325





## LAVELLI

### Sinks

L'acqua sembra giocare in questi splendidi fondi d'acciaio dall'igiene perfetta. Forza, resistenza e stile.

*The water seems to play in these beautiful, perfectly hygienic steel sinks. Strength, durability and style.*



Tutti i lavelli con h. 180/200 sono provvisti di feritoie laterali per l'utilizzo del sifone, tutti i lavelli con h. 250/300 sono progettati per l'utilizzo del tubo "troppo pieno". Sia il sifone che il tubo vanno richiesti al momento dell'ordine.

Inoltre va specificato se si desidera il foro a sinistra o a destra, oltre agli accessori.

Le misure delle vasche servono anche come indicazioni del foro da praticare nel bancone.

*Siphon: to be used only with sinks with depth 180/200 mm. S/S tube: to be used only with sinks with depth 250/300 mm. Both have to be requested when placing an order. Please also specify if and where you'd like the bottom hole and any accessories.*

*The sink measures listed in this catalogue can be used for reference on where to drill your counter or table.*

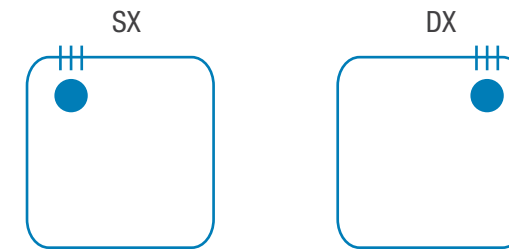

h. 200 o inferiore prevista per SIFONE  
Siphon: used for sinks h. 200 mm or less

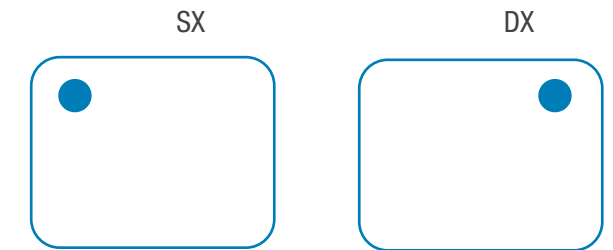

h. 250 o superiore prevista con TUBO in acciaio  
S/S Tube: used for sinks h. 250 mm or more

B/P BORDO PIANO A SALDARE / Flat margin to be welded



B/A BORDO APPOGGIO / Sink to be set





### VASCHE A SALDARE - CON BORDO PIANO

Sinks to be welded

MODELLO <i>Model</i>	DESCRIZIONE <i>Description</i>
600x500x300	foro fondo SX <i>bottom hole only, LEFT side</i>
600x500x300	foro fondo DX <i>bottom hole only, RIGHT side</i>
600x500x300	foro fondo e feritoie SX <i>bottom hole and overflow holes LEFT side</i>
600x500x300	foro fondo e feritoie DX <i>bottom hole and overflow holes RIGHT side</i>
600x450x250	foro fondo SX <i>bottom hole only, LEFT side</i>
600x450x250	foro fondo DX <i>bottom hole only, RIGHT side</i>
600x450x250	foro fondo e feritoie SX <i>bottom hole and overflow holes LEFT side</i>
600x450x250	foro fondo e feritoie DX <i>bottom hole and overflow holes RIGHT side</i>
600x450x300	foro fondo SX <i>bottom hole only, LEFT side</i>
600x450x300	foro fondo DX <i>bottom hole only, RIGHT side</i>
600x450x300	foro fondo e feritoie SX <i>bottom hole and overflow holes LEFT side</i>
600x450x300	foro fondo e feritoie DX <i>bottom hole and overflow holes RIGHT side</i>
500x400x200	foro fondo SX <i>bottom hole only, LEFT side</i>
500x400x200	foro fondo DX <i>bottom hole only, RIGHT side</i>
500x400x200	foro fondo e feritoie SX <i>bottom hole and overflow holes LEFT side</i>
500x400x200	foro fondo e feritoie DX <i>bottom hole and overflow holes RIGHT side</i>
500x400x250	foro fondo SX <i>bottom hole only, LEFT side</i>
500x400x250	foro fondo DX <i>bottom hole only, RIGHT side</i>
500x400x250	foro fondo e feritoie SX <i>bottom hole and overflow holes LEFT side</i>
500x400x250	foro fondo e feritoie DX <i>bottom hole and overflow holes RIGHT side</i>



### VASCHE A SALDARE - CON BORDO PIANO

Sinks to be welded

500x400x300	foro fondo SX <i>bottom hole only, LEFT side</i>
500x400x300	foro fondo DX <i>bottom hole only, RIGHT side</i>
500x400x300	foro fondo e feritoie SX <i>bottom hole and overflow holes LEFT side</i>
500x400x300	foro fondo e feritoie DX <i>bottom hole and overflow holes RIGHT side</i>
500x500x250	foro fondo <i>bottom hole only</i>
500x500x250	foro fondo e feritoie SX <i>bottom hole and overflow holes LEFT side</i>
500x500x250	foro fondo e feritoie DX <i>bottom hole and overflow holes RIGHT side</i>
500x500x300	foro fondo <i>bottom hole only</i>
500x500x300	foro fondo e feritoie SX <i>bottom hole and overflow holes LEFT side</i>
500x500x300	foro fondo e feritoie DX <i>bottom hole and overflow holes RIGHT side</i>
450x450x200	foro fondo <i>bottom hole only</i>
450x450x200	foro fondo e feritoie SX <i>bottom hole and overflow holes LEFT side</i>
450x450x200	foro fondo e feritoie DX <i>bottom hole and overflow holes RIGHT side</i>
450x450x250	foro fondo <i>bottom hole only</i>
450x450x250	foro fondo e feritoie SX <i>bottom hole and overflow holes LEFT side</i>
450x450x250	foro fondo e feritoie DX <i>bottom hole and overflow holes RIGHT side</i>
450x450x300	foro fondo <i>bottom hole only</i>
450x450x300	foro fondo e feritoie SX <i>bottom hole and overflow holes LEFT side</i>
450x450x300	foro fondo e feritoie DX <i>bottom hole and overflow holes RIGHT side</i>

### VASCHE A SALDARE - CON BORDO PIANO

Sinks to be welded

MODELLO <i>Model</i>	DESCRIZIONE <i>Description</i>
400x400x200	foro fondo <i>bottom hole only</i>
400x400x200	foro fondo e feritoie SX <i>bottom hole and overflow holes LEFT side</i>
400x400x200	foro fondo e feritoie DX <i>bottom hole and overflow holes RIGHT side</i>
400x400x250	foro fondo SX <i>bottom hole only, LEFT side</i>
400x400x250	foro fondo e feritoie SX <i>bottom hole and overflow holes LEFT side</i>
400x400x250	foro fondo e feritoie DX <i>bottom hole and overflow holes RIGHT side</i>
400x400x300	foro fondo SX <i>bottom hole only, LEFT side</i>
400x400x300	foro fondo e feritoie SX <i>bottom hole and overflow holes LEFT side</i>
400x400x300	foro fondo e feritoie DX <i>bottom hole and overflow holes RIGHT side</i>
340x400x200	foro fondo SX <i>bottom hole only, LEFT side</i>
340x400x200	foro fondo DX <i>bottom hole only, RIGHT side</i>
340x400x200	foro fondo e feritoie SX <i>bottom hole and overflow holes LEFT side</i>
340x400x200	foro fondo e feritoie DX <i>bottom hole and overflow holes RIGHT side</i>
340x400x250	foro fondo SX <i>bottom hole only, LEFT side</i>
340x400x250	foro fondo DX <i>bottom hole only, RIGHT side</i>
340x400x250	foro fondo e feritoie SX <i>bottom hole and overflow holes LEFT side</i>
340x400x250	foro fondo e feritoie DX <i>bottom hole and overflow holes RIGHT side</i>
340x400x300	foro fondo SX <i>bottom hole only, LEFT side</i>
340x400x300	foro fondo DX <i>bottom hole only, RIGHT side</i>
340x400x300	foro fondo e feritoie SX <i>bottom hole and overflow holes LEFT side</i>
340x400x300	foro fondo e feritoie DX <i>bottom hole and overflow holes RIGHT side</i>



### VASCHE A SALDARE - CON BORDO PIANO

Sinks to be welded

MODELLO <i>Model</i>	DESCRIZIONE <i>Description</i>
330x330x200	foro fondo <i>bottom hole only</i>
330x330x200	foro fondo e feritoie SX <i>bottom hole and overflow holes LEFT side</i>
330x330x200	foro fondo e feritoie DX <i>bottom hole and overflow holes RIGHT side</i>
330x235x180	foro fondo <i>bottom hole only</i>
330x235x180	foro fondo e feritoie SX <i>bottom hole and overflow holes LEFT side</i>
290x400x200	foro fondo SX <i>bottom hole only, LEFT side</i>
290x400x200	foro fondo DX <i>bottom hole only, RIGHT side</i>
290x400x200	foro fondo e feritoie SX <i>bottom hole and overflow holes LEFT side</i>
290x400x200	foro fondo e feritoie DX <i>bottom hole and overflow holes RIGHT side</i>
290x350x200	foro fondo SX <i>bottom hole only, LEFT side</i>
290x350x200	foro fondo DX <i>bottom hole only, RIGHT side</i>
290x350x200	foro fondo e feritoie SX <i>bottom hole and overflow holes LEFT side</i>
290x350x200	foro fondo e feritoie DX <i>bottom hole and overflow holes RIGHT side</i>
250x250x200	foro fondo <i>bottom hole only</i>
250x250x200	foro fondo e feritoie SX <i>bottom hole and overflow holes LEFT side</i>
250x250x200	foro fondo e feritoie DX <i>bottom hole and overflow holes RIGHT side</i>
330x235x180	foro fondo <i>bottom hole only</i>
330x235x180	foro fondo e feritoie SX <i>bottom hole and overflow holes LEFT side</i>



## VASCHE CON BORDO APPOGGIO

Sinks to be set

MODELLO Model	DESCRIZIONE Description
400x400x300	foro fondo <i>bottom hole only</i>
400x400x300	foro fondo e feritoie SX <i>bottom hole and overflow holes LEFT side</i>
400x400x300	foro fondo e feritoie DX <i>bottom hole and overflow holes RIGHT side</i>
400x400x250	foro fondo SX <i>bottom hole only, LEFT side</i>
400x400x250	foro fondo e feritoie SX <i>bottom hole and overflow holes LEFT side</i>
400x400x250	foro fondo e feritoie DX <i>bottom hole and overflow holes RIGHT side</i>
400x400x200	foro fondo SX <i>bottom hole only, LEFT side</i>
400x400x200	foro fondo e feritoie SX <i>bottom hole and overflow holes LEFT side</i>
400x400x200	foro fondo e feritoie DX <i>bottom hole and overflow holes RIGHT side</i>
330x330x200	foro fondo <i>bottom hole only</i>
330x330x200	foro fondo e feritoie SX <i>bottom hole and overflow holes LEFT side</i>
330x330x200	foro fondo e feritoie DX <i>bottom hole and overflow holes RIGHT side</i>
330x235x180	foro fondo <i>bottom hole only</i>
330x235x180	foro fondo e feritoie SX <i>bottom hole and overflow holes LEFT side</i>
330x235x180	foro fondo e feritoie DX <i>bottom hole and overflow holes RIGHT side</i>



## VASCA TONDA CON BORDO APPOGGIO

Round sink to be set

MODELLO Model	DESCRIZIONE Description
420x180	foro fondo e feritoie <i>bottom hole and overflow holes</i>
380x180	foro fondo e feritoie <i>bottom hole and overflow holes</i>
360x180	foro fondo e feritoie <i>bottom hole and overflow holes</i>
300x180	foro fondo e feritoie <i>bottom hole and overflow holes</i>
260x180	foro fondo e feritoie <i>bottom hole and overflow holes</i>

## VASCA TONDA CON BORDO A SALDARE

Round sink to be welded

MODELLO Model	DESCRIZIONE Description
420x180	foro fondo e feritoie <i>bottom hole and overflow holes</i>
380x180	foro fondo e feritoie <i>bottom hole and overflow holes</i>
360x180	foro fondo e feritoie <i>bottom hole and overflow holes</i>
300x180	foro fondo e feritoie <i>bottom hole and overflow holes</i>

\* Vasca lucidata a specchio / Basin mirror polished

\* Le misure delle vasche servono anche come indicazioni del foro da praticare nel bancone  
\* Basins measures can also be useful as indication for the hole to be made in the counter.

# LAVELLI INOX

SST sinks

## ACCESSORI PER VASCHE

Accessories for sinks

### MODELLO

Sifone con tubo flex in PR completo  
Flexible polypropylene tube with overflow

\*Sifone: da utilizzare su lavelli con una profondità di 180/200 mm  
\*Siphon: to be used with basins with depth 180/200 mm.



### MODELLO

Sifone con tubo rigido in PR completo  
Plastic fix siphon complete for sinks



### MODELLO

Piletta solo per tubi in inox  
Filter d.54 only for SST tube



MODELLO Model	PER VASCHE For basins
Tubo inox 158 mm Ø 54 SST tube 158 mm Ø 54	H 180 mm
Tubo inox 188 mm Ø 54 SST tube 188 mm Ø 54	H 200 mm
Tubo inox 235 mm Ø 54 SST tube 235 mm Ø 54	H 250 mm
Tubo inox 270 mm Ø 54 SST tube 270 mm Ø 54	H 300 mm



## ACCESSORI PER VASCHE

Accessories for sinks

MODELLO Model	DESCRIZIONE Description
330x235x180	Lavello completo con vasca Column sink with square basin
330x330x200	Lavello completo con vasca Column sink with square basin

MODELLO Model	DESCRIZIONE Description
330x235x180	Lavello completo a ginocchio Knee-deep sink with square basin
330x330x200	Lavello completo a ginocchio Knee-deep sink with square basin

MODELLO Model	DESCRIZIONE Description
d. 250x170	Lava mani comp. c/vasca tonda Knee-deep sink with round basin





## CARRELLI Trolleys

**SEMPRE PIU' FORTI!**  
I nostri carrelli d'acciaio sono il mezzo ideale per trasportare, sbarazzare, appoggiare.  
Praticità vuol dire anche... velocità.

**ALWAYS THE STRONGEST!**  
*Our steel trolleys are the ideal way to carry, to get rid of, and to support.  
Convenience also means... speed.*

Per il trasporto di qualsiasi contenitore, cibi vari etc, INOX MACEL ha realizzato una bellissima e completa linea di carrelli esclusivamente prodotti in acciaio Aisi 304, disponibili in diverse misure e modelli.

*For the transport of any container, various foods, etc, INOX MACEL offers a beautiful and complete line of AISI 304 steel trolleys, available in different models and sizes.*

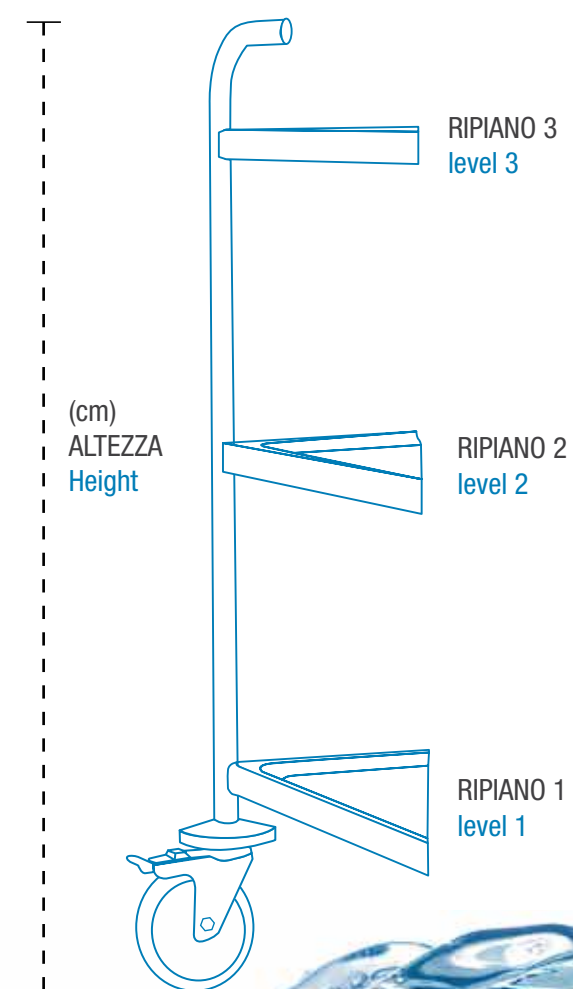

## CARRELLI ACCIAIO INOX AISI 304

Aisi 304 s/s trolleys

### CARRELLI INOX DA SERVIZIO SALDATI

SST welded service trolleys

CODICE code	DIM. MM dim. mm	DESCRIZIONE description	RIPIANI shelves	RUOTE wheels
CA60402RV	600x400x935 h	Saldato, gomma antivibrazioni Welded, antivibration rubber	2	4 girevoli, 2 freni 4 revolving, 2 brakes
CA60403RV	600x400x935 h	Saldato, gomma antivibrazioni Welded, antivibration rubber	2	4 girevoli, 2 freni 4 revolving, 2 brakes
CAIM0802R	800x500x935 h	Saldato, gomma antivibrazioni Welded, antivibration rubber	2	4 girevoli, 2 freni 4 revolving, 2 brakes
CAIM0803R	800x500x935 h	Saldato, gomma antivibrazioni Welded, antivibration rubber	3	4 girevoli, 2 freni 4 revolving, 2 brakes
CAIM1002R	1000x500x935 h	Saldato, gomma antivibrazioni Welded, antivibration rubber	2	4 girevoli, 2 freni 4 revolving, 2 brakes
CAIM1003R	1000x500x935 h	Saldato, gomma antivibrazioni Welded, antivibration rubber	3	4 girevoli, 2 freni 4 revolving, 2 brakes



### CARRELLI INOX DA SERVIZIO DA ASSEMBLARE, CON PIANETTE DA AVVITARE

SST flat-pack service trolleys with bolted shelves

CODICE code	DIM. MM dim. mm	DESCRIZIONE description	RIPIANI shelves	RUOTE wheels
CAIM0802RSM	800x500x935 h	Da assemblare, gomma antivibrazioni Flat-pack, antivibration rubber	2	4 girevoli, 2 freni 4 revolving, 2 brakes
CAIM0803RSM	800x500x935 h	Da assemblare, gomma antivibrazioni Flat-pack, antivibration rubber	3	4 girevoli, 2 freni 4 revolving, 2 brakes
CAIM100SRSM	1000x500x935 h	Da assemblare, gomma antivibrazioni Flat-pack, antivibration rubber	2	4 girevoli, 2 freni 4 revolving, 2 brakes
CAIM1003RSM	1000x500x935 h	Da assemblare, gomma antivibrazioni Flat-pack, antivibration rubber	3	4 girevoli, 2 freni 4 revolving, 2 brakes

\* Carrelli smontati forniti di viti e chiave per un facile montaggio.

\* Comes flat-packed; easy to assemble and provided with wrenches and bolts.



### CARRELLI INOX DA SERVIZIO DA ASSEMBLARE, CON PIANETTE SALDATE

SST flat-pack service trolleys with welded shelves

CODICE code	DIM. MM dim. mm	DESCRIZIONE description	RIPIANI shelves	RUOTE wheels
CAIM8050N2R	800x500x935 h	Da assemblare, gomma antivibrazioni Flat-pack, antivibration rubber	2	4 girevoli, 2 freni 4 revolving, 2 brakes
CAIM8050N3R	800x500x935 h	Da assemblare, gomma antivibrazioni Flat-pack, antivibration rubber	3	4 girevoli, 2 freni 4 revolving, 2 brakes
CAIM10050N2R	1000x500x935 h	Da assemblare, gomma antivibrazioni Flat-pack, antivibration rubber	2	4 girevoli, 2 freni 4 revolving, 2 brakes
CAIM10050N3R	1000x500x935 h	Da assemblare, gomma antivibrazioni Flat-pack, antivibration rubber	3	4 girevoli, 2 freni 4 revolving, 2 brakes

\* Montaggio con inserti in plastica e martello, senza viti.

\* To be assembled with pivots and hammer, free from bolts



### CARRELLO INOX SALDATO 450X620X940MM PER CONTENITORI GN 1/1

SST welded trolley 450x620x940mm for gn containers 1/1

CODICE code	DIM. MM dim. mm	DESCRIZIONE description	RIPIANI shelves	RUOTE wheels
CA1478	450x620x940 h	Saldato Welded	8	4 girevoli, 2 freni 4 revolving, 2 brakes

### CARRELLO INOX DA ASSEMBLARE 380X550X1750MM PER CONTENITORI GN 1/1

SST welded trolley 380x550x1750mm for gn containers 1/1

CODICE code	DIM. MM dim. mm	DESCRIZIONE description	RIPIANI shelves	RUOTE wheels
CA1450	380x550x1750 h	Da assemblare Flat-pack	10	4 girevoli, 2 freni 4 revolving, 2 brakes

### CARRELLO INOX DA ASSEMBLARE 380X550X1820MM PER VASSOI E CONTENITORI GN 1/1

SST flat-pack trolley 380x550x1820mm for trays and gn containers 1/1

CODICE code	DIM. MM dim. mm	DESCRIZIONE description	RIPIANI shelves	RUOTE wheels
CA1/114L	380x550x1820 h	Da assemblare Flat-pack	14	4 girevoli, 2 freni 4 revolving, 2 brakes

### CARRELLO INOX DA ASSEMBLARE 740X550X1750MM PER GN 1/1

SST flat-pack trolley 740x550x1750mm for gn containers 1/1

CODICE code	DIM. MM dim. mm	DESCRIZIONE description	RIPIANI shelves	RUOTE wheels
CA1460	740x550x1750 h	Da assemblare Flat-pack	20	4 girevoli, 2 freni 4 revolving, 2 brakes



## CARRELLI ACCIAIO INOX AISI 304

Aisi 304 s/s trolleys

**CARRELLO INOX DA ASSEMBLARE 650X720X940MM PER 8 GN 2/1 O 16 GN 1/1**  
*SST flat-pack trolley 650x720x940mm for 8 gn 2/1 or 16 gn 1/1*

CODICE <i>code</i>	DIM. MM <i>dim. mm</i>	DESCRIZIONE <i>description</i>	RIPIANI <i>shelves</i>	RUOTE <i>wheels</i>
CA1477	650x720x940 h	Da assemblare <i>Flat-pack</i>	8/16	4 girevoli, 2 freni <i>4 revolving, 2 brakes</i>



**CARRELLO INOX DA ASSEMBLARE 580X650X1820MM PER 14 GN 2/1 O 28 GN 1/1**  
*SST flat-pack trolley 580x650x1820mm for 14 gn 2/1 or 28 gn 1/1*

CODICE <i>code</i>	DIM. MM <i>dim. mm</i>	DESCRIZIONE <i>description</i>	RIPIANI <i>shelves</i>	RUOTE <i>wheels</i>
CA2/114L	580x650x1820 h	Da assemblare <i>Flat-pack</i>	14 /28	4 girevoli, 2 freni <i>4 revolving, 2 brakes</i>



## CONTENITORI RACCOGLIPOSATE

*Containers for cutlery*

CODICE <i>code</i>	DIM. MM <i>dim. mm</i>	DESCRIZIONE <i>description</i>
13150CG	32,5x17,6x15cm	si appende ai carrelli servizio <i>to be hung on service trolleys</i>
G4225CG	42x25x20cm	si appende ai carrelli servizio <i>to be hung on service trolleys</i>



## CARATTERISTICHE TECNICHE CARRELLI ACCIAIO INOX

*SST trolleys technical features*

PRODOTTI IN ACCIAIO AISI304 PER LA MIGLIORE RESISTENZA ALLA CORROSIONE;  
UN ACCIAIO AUTENTICO E IDEALE PER IL CONTATTO CON GLI ALIMENTI.  
*Made in AISI 304 to ensure maximum resistance to corrosion, a high quality genuine steel perfect for food contact.*

TUBI IN ACCIAIO INOSSIDABILE; 4 RUOTE GIREVOLI INSONORIZZATE, Ø 125MM,  
DI CUI DUE COL FRENO. SI REALIZZANO ANCHE MODELLI SU MISURA.  
*Stainless steel tubes; 4 revolving soundproof wheels, Ø 125mm (two with brakes). Customized models available.*







## GANCI

*Hooks*

Nelle altezze... Assicurano il vostro prodotto. Misure e modelli diversi che reggono qualsiasi peso e soddisfano anche esigenze di igiene assoluta. Ganci di grande qualità per... salire di livello.

*From the heights of excellence... they ensure your products.*  
*All sort of models that carry any weight and that meet all requirements of absolute hygiene.*  
*Hooks of great quality... to go up a level.*

Un'ampia gamma di ganci di diverso genere e misura, batticarne, seghetti, carrucole e spiedini. È interamente realizzata in acciaio inox Aisi 420 e/o 304. Inox Macel ha la possibilità di realizzare qualsiasi tipo, modello e misura di gancio a disegno, previo quantitativo minimo.

*A wide range of different types and sizes of hooks, meat pounders, hacksaws, skewers... Made only with stainless steel AISI420 and 304.*  
*Inox Macel has the ability to realise any type, model and size of hook accordingly with your needs.*

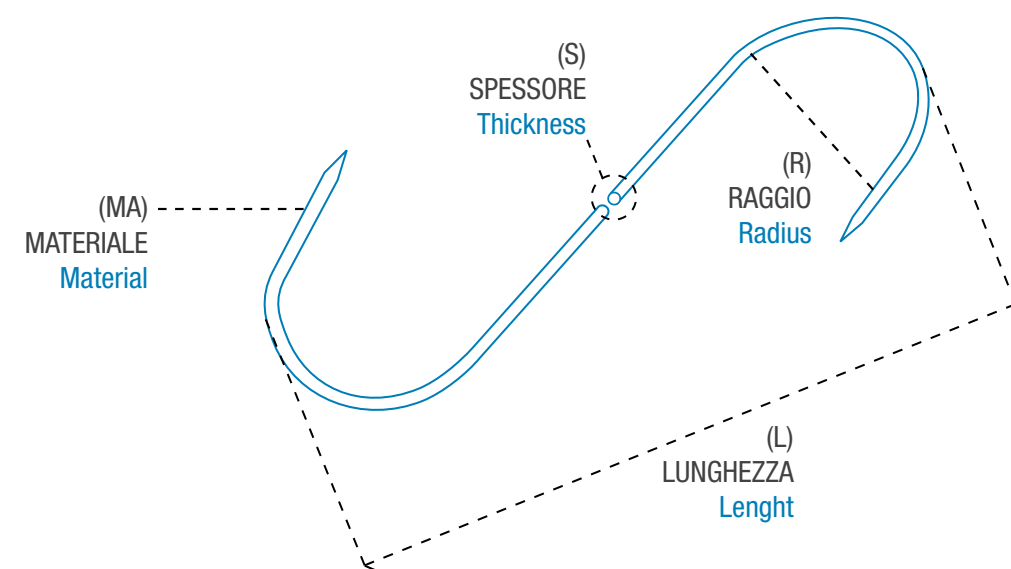



**GANCIO FISSO A 2 PUNTE**

*Two points fixed hook*

CODICE <i>Code</i>	DIMENSIONI in mm <i>Dimensions</i>	MAX. Kg <i>Max load</i>	Raggio <i>Radius</i>
010001	60x3	25	2,1
010002	80x3	25	2,3
010003	80x4	40	3,0
010004	100x4	40	3,2
010005	100x5	50	3,2
010006	120x5	50	3,6
010007	140x5	50	3,8
010008	140x6	70	3,8
010009	160x6	70	4,3
010010	180x6	70	4,3
010011	180x7	80	5,1
010012	180x8	90	5,7
010013	200x9	120	5,6
010014	220x9	120	5,6
010015	250x10	140	5,7
010016	300x12	180	6,9
010017	400x12	180	7,2
010018	500x12	180	7,5
010019	750x12	180	8,3
010020	1000x12	180	9,1



**GANCIO FISSO A 1 PUNTA**

*One point fixed hook*

CODICE <i>Code</i>	DIMENSIONI in mm <i>Dimensions</i>	MAX. Kg <i>Max load</i>	Raggio <i>Radius</i>
012001	60x3	25	2,1
012002	80x3	25	2,3
012003	80x4	40	3,0
012004	100x4	40	3,2
012005	100x5	50	3,2
012006	120x5	50	3,6
012007	140x5	50	3,8
012008	140x6	70	3,8
012009	160x6	70	4,3
012010	180x6	70	4,3
012011	180x7	80	5,1
012012	180x8	90	5,7
012013	200x9	120	5,6
012014	220x9	120	5,6
012015	250x10	140	5,7
012016	300x12	180	6,9
012017	400x12	180	7,2
012018	500x12	180	7,5
012019	750x12	180	8,3
012020	1000x12	180	9,1



**GANCIO RAGGIO MAXI 1 PUNTA**

*One point hooks with maxi radius*

CODICE <i>Code</i>	DIMENSIONI in mm <i>Dimensions</i>	MAX. Kg <i>Max load</i>	Raggio <i>Radius</i>
015001	120x5	50	4,2
015002	140x5	50	5,7
015003	140x6	70	5,9
015004	160x6	70	5,5
015005	180x6	70	5,5
015006	180x8	90	6,2
015007	200x10	140	6,8

**GANCIO GIRANDOLA 18/10**

*Revolving wheel hook 18/10*

CODICE <i>Code</i>	DIMENSIONI in mm <i>Dimensions</i>	MAX. Kg <i>Max load</i>	Raggio <i>Radius</i>
033051	400x600	100	4,1

**GANCIO GIREVOLE 1 PUNTA**

*One point revolving hook*

CODICE <i>Code</i>	DIMENSIONI in mm <i>Dimensions</i>	MAX. Kg <i>Max load</i>	Raggio <i>Radius</i>
019001	220x9	120	5,2
019002	240x10	140	6,2
019004	270x12	180	6,5
019005	300x12	180	6,7
019006	400x12	180	6,7
019007	500x12	180	6,7
019008	750x12	180	6,7

**GANCIO ANCORA GIREVOLE**

*Revolving anchor hook*

CODICE <i>Code</i>	DIMENSIONI in mm <i>Dimensions</i>	MAX. Kg <i>Max load</i>
020001	320x230x10	140
020002	320x280x12	180



## GANCI Hooks

### GANCIO AD ANCORA IN 18/8 CON ANELLO

Anchor hook in 18/8 with ring

CODICE Code	DIMENSIONI in mm Dimensions	MAX. Kg Max load
022001	300x12	300

### GANCIO MOD. C CON MANICO IN ALLUMINIO

Hook Mod. C with aluminium handle

CODICE Code	DIMENSIONI in mm Dimensions	MAX. Kg Max load
031001	165x7	50

### GANCIO A TESTA PIATTA

Hook with flat head

CODICE Code	DIMENSIONI in mm Dimensions	MAX. Kg Max load
058001	170x12	180

### CARRUCOLA IN PLASTICA CON GANCIO

Plastic pulley with hook

CODICE Code	DIMENSIONI in mm Dimensions	MAX. Kg Max load
059051	170x12	180

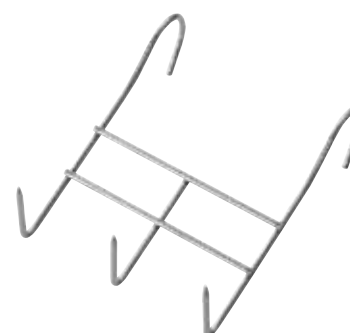
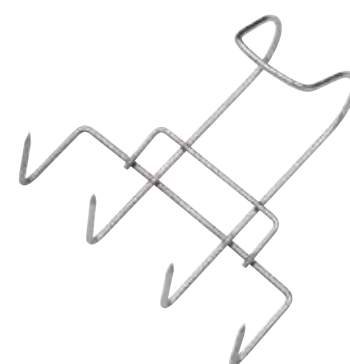

## APPENDIPANCETTA Bacon Hooks

### APPENDIPANCETTA A 4 P. E UN ATTACCO GRANDE

Baconhook with 4 holds and one big hook

CODICE Code	DIMENSIONI in mm Dimensions	MAX. Kg Max load
0280511	60x140x4	15

### APPENDIPANCETTA A 3 P. E 2 ATTACCHI POSTERIORI

Baconhook with 3 holds and two back hooks

CODICE Code	DIMENSIONI in mm Dimensions	MAX. Kg Max load
030051	150x120x4	15

### SPIEDINI PIATTI

Skewers

CODICE Code	DIMENSIONI in mm Dimensions
077001	100x3
077002	150x3
077003	200x3
077004	250x3
077005	300x3
077006	350x3
077007	400x3
079001	560x5

### SPADE

Swords

CODICE Code	DIMENSIONI in mm Dimensions
078502	600x15x3
078002	700x15x3
078003	700x20x2

## ACCESSORI *Butcher tools*

### BATTICARNE INOX *St/St meat pounder*

CODICE <i>Code</i>	PESO <i>Weight</i>
080002	0,8 Kg
080003	1 Kg
080004	1,5 Kg
080006	2 Kg



### CAMPANA RASCHIATRICE SENZA MOLLA *Bell scraper without spring*

CODICE <i>Code</i>	DIMENSIONI in mm <i>Dimensions</i>
037001	H 190 Ø 70



### CAMPANA RASCHIATRICE CON MOLLA *Bell scraper with spring*

CODICE <i>Code</i>	DIMENSIONI in mm <i>Dimensions</i>
037002	H 190 Ø 70



### TAGLIANERVI OVALE CON LAMIERE 150x100 *Oval nerve meat cutter with 18/8 blades*

CODICE <i>Code</i>	DIMENSIONI in mm <i>Dimensions</i>
036150	150x100



### TAGLIANERVI ROTONDO CON LAMIERE *Round nerve meat cutter with 18/8 blades*

CODICE <i>Code</i>	DIMENSIONI in mm <i>Dimensions</i>
TNERV6080	Ø 60x807



## SEGHETTI *Hacksaws*

### SEGHETTO FISSAGGIO RAPIDO *St/St hacksaw rapid clamping*

CODICE <i>Code</i>	DIMENSIONI in mm <i>Dimensions</i>
084101	400
084102	450
084103	500
084104	550



### SEGHETTO AD ARCO *St/St hacksaw*

CODICE <i>Code</i>	DIMENSIONI in mm <i>Dimensions</i>
084001	400
084002	450
084003	500
084004	550





### LAME PER SEGHETTO A FISSAGGIO RAPIDO

*Spare part for rapid clamping*

CODICE <i>Code</i>	DIMENSIONI in mm <i>Dimensions</i>
084601	400
084602	450
084603	500



### LAME PER SEGHETTO AD ARCO

*Spare part for hacksaw*

CODICE <i>Code</i>	DIMENSIONI in mm <i>Dimensions</i>
084501	400
084502	450
084503	500



### PINZA INOX 115x50

*18/8 tong 115x50*

CODICE <i>Code</i>	DIMENSIONI in mm <i>Dimensions</i>
036051	115x50



### PINZA INOX EXPORT 105x75

*18/8 tong export 105x75*

CODICE <i>Code</i>	DIMENSIONI in mm <i>Dimensions</i>
036052	105x75







## CESTELLI *Racks*

Sono sottoposte alla forza veemente dell'acqua ma... le nostre ceste sono tutte d'un pezzo!

*No matter how strong the current, our racks... are always sturdy!*

Rappresentano una delle novità nella produzione. Si distinguono in basi e rialzi stampati a corpo unico, lati aperti per una perfetta detergenza. Le basi monocolori (grigio) sono provviste di scomparti interni per i diversi diametri di bicchieri, brocche, piatti, vassoi e posate.

I rialzi monocolori (blu) permettono di raggiungere l'altezza ideale per il lavaggio e stoccaggio dei bicchieri, seguendo di conseguenza le forme delle basi. Per un migliore riconoscimento delle stoviglie stoccate, la linea si completa con diversi accessori, dal coperchio alle clips, di diverso colore.

*They represent one of the innovations in our production. They are distinguished between bases and extenders, all printed in one piece, with open sides for better cleaning. The grey bases are equipped with internal compartments for different diameters of glasses, pitchers, plates, trays and cutlery.*

*The blue extenders help to reach the ideal height for washing and stocking, matching the shape of the bases. To make it easier to recognize different kitchenware, this line is complemented with various accessories, from covers to clips, all with different colours.*

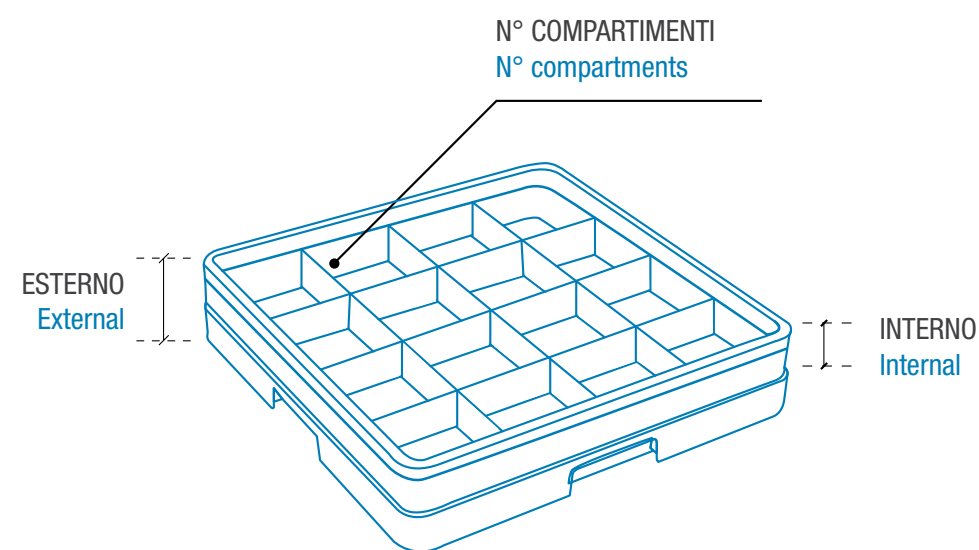



## CESTELLI PER LAVASTOVIGLIE 50X50CM

Dishwasher racks 50x50 cm

### BASE UNIVERSALE GRIGIA

Grey universal rack base

CODICE  
code

DIM. INTERNE MM  
int. dimens. mm

RBASE 476x476

### BASE CON 9 SCOMPARTI GRIGIA

Grey rack base with 9 compartments

CODICE  
code

SCOMPARTI  
compartments

DIM. SCOMPARTI  
dim. compartments

RBASE09 9 151x151x88

### BASE CON 16 SCOMPARTI GRIGIA

Grey rack base with 16 compartments

CODICE  
code

SCOMPARTI  
compartments

DIM. SCOMPARTI  
dim. compartments

RBASE16 16 115x115x88

### BASE CON 25 SCOMPARTI GRIGIA

Grey rack base with 25 compartments

CODICE  
code

SCOMPARTI  
compartments

DIM. SCOMPARTI  
dim. compartments

RBASE25 25 88x88x88

### BASE CON 36 SCOMPARTI GRIGIA

Grey rack base with 36 compartments

CODICE  
code

SCOMPARTI  
compartments

DIM. SCOMPARTI  
dim. compartments

RBASE36 36 73x73x88

### BASE CON 49 SCOMPARTI GRIGIA

Grey rack base with 49 compartments

CODICE  
code

SCOMPARTI  
compartments

DIM. SCOMPARTI  
dim. compartments

RBASE49 49 62x62x88



### BASE CON 20 SCOMPARTI GRIGIA PER TAZZE

Grey rack base with 20 compartments for cups

CODICE  
code

SCOMPARTI  
compartments

DIM. SCOMPARTI  
dim. compartments

RBASE20T 20 115x93x78

### BASE PER POSATE GRIGIA - APERTA

Grey rack base for cutlery - open

CODICE  
code

DIM. INTERNE MM  
int. dimens. mm

RBASEPO 476x476

### BASE GRIGIA PER VASSOI CON UN LATO APERTO

Grey rack base for trays - one open side

CODICE  
code

DIM. INTERNE MM  
int. dimens. mm

RBASEVA 476x476

### BASE GRIGIA CON LATI CHIUSI PER VASSOI E PIATTI

Grey rack base for plates with closed sides

CODICE  
code

DIM. INTERNE MM  
int. dimens. mm

RBASEPV 476x476

### RIALZO PER BASE UNIVERSALE BLU - APERTO

Blue universal extender - open

CODICE  
code

DIM. INTERNE MM  
int. dimens. mm

RALZ 476x476

## CESTELLI PER LAVASTOVIGLIE 50X50CM

Dishwasher racks 50x50 cm

### RIALZO PER BASE 9 SCOMPARTI BLU

Blue extender with 9 compartments

CODICE code	SCOMPARTI compartments	DIM. SCOMPARTI dim. compartments
RALZ09	9	151x151x42

### RIALZO PER BASE 16 SCOMPARTI BLU

Blue extender with 16 compartments

CODICE code	SCOMPARTI compartments	DIM. SCOMPARTI dim. compartments
RALZ16	16	115x115x42

### RIALZO PER BASE 25 SCOMPARTI BLU

Blue extender with 25 compartments

CODICE code	SCOMPARTI compartments	DIM. SCOMPARTI dim. compartments
RALZ25	25	88x88x42

### RIALZO PER BASE 36 SCOMPARTI BLU

Blue extender with 36 compartments

CODICE code	SCOMPARTI compartments	DIM. SCOMPARTI dim. compartments
RALZ36	36	73x73x42

### RIALZO PER BASE 49 SCOMPARTI BLU

Blue extender with 49 compartments

CODICE code	SCOMPARTI compartments	DIM. SCOMPARTI dim. compartments
RALZ49	49	62x62x42

### COPERCHIO PER CESTE BLU

blue lid for racks

CODICE code	DIM. dim.
RCOP	500x500

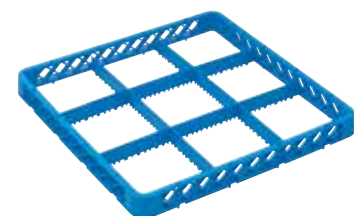

74



75

### CLIPS COLORATE PER BASI

Coloured clips for racks

CODICE Code	COLORI Colours	
RCLIPSB	BIANCA / White	
RCLIPSN	NERO / Black	
RCLIPSBLU	BLU / Blue	
RCLIPSG	GIALLO / Yellow	
RCLIPSR	ROSSO / Red	
RCLIPSV	VERDE / Green	
RCLIPSM	MARRONE / Brown	

### TELO COPRENTE IN PLASTICA PER CESTELLI

Plastic transparent cover for racks

CODICE code	DIM. dim.
COPRICESTA	550x550x1200 h

### CARRELLINI PER CESTE PER LO STOCCAGGIO

Blue trolley without handle for racks

CODICE code	DIM. dim.
RCARR	575x545x210

\*Carrello con 4 ruote di cui 2 girevoli e 2 fisse  
\*4 wheels trolley: 2 revolving braked and 2 fixed without brakes

### CARRELLINI PER CESTE PER LO STOCCAGGIO

Blue trolley with handle for racks

CODE code	DIM. dim.	H CON LA MANIGLIA h with handle
RCARRM	575x545x210	920mm

\*Carrello con 4 ruote di cui 2 girevoli e 2 fisse  
\*4 wheels trolley: 2 revolving braked and 2 fixed without brakes

### MANIGLIONE IN INOX PER CARRELLO PORTA CESTE

SST big handle for trolley for racks

CODICE code	DIM. dim.	H IN MM h in mm
RMANCARR	740x540	740



## CESTELLI PER LAVASTOVIGLIE 50X50CM

Dishwasher racks 50x50 cm

### PORTAPOSATE A 4 SCOMPARTI

Rack for cutlery with 4 compartments

CODICE code	COLORE colour	SCOMPARTI compartments	DIM. SCOMPARTI dim. compartments
RCEST04	Grigio / Grey	4	530x325x100
RCEST04B	Blu / Blue	4	530x325x100

### COPERCHIO BIANCO SOVRAPPONIBILE PER PORTAPOSATE A 4 SCOMPARTI

Stackable transparent lid for cutlery box with 4 compartments

CODICE code	DIM. IN MM dim. in mm
RCOP4	530x325

### PORTAPOSATE A 8 SCOMPARTI BLU

Blue rack for cutlery with 8 compartments

CODICE code	SCOMPARTI compartments	DIM. SCOMPARTI dim. compartments
RCEST08	8	430x205x14

## CESTELLI PER LAVASTOVIGLIE 50X50 CM

Dishwasher racks 50x50 cm

### MANIGLIA IN ACCIAIO INOX PER PORTAPOSATE A 8 SCOMPARTI / SST handle for item rcest08

CODICE  
code

RMAN

### PORTAPOSATE SINGOLO BLU

Blue rack for cutlery with 1 compartment

CODICE code	SCOMPARTI compartments
RCEST01	1

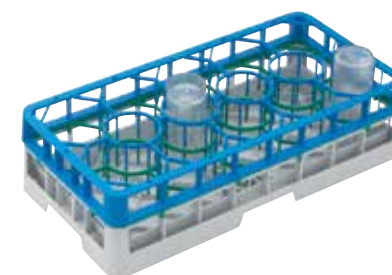

## CESTELLI PER LAVASTOVIGLIE 50X25 CM

Dishwasher racks 50x25 cm

### BASE UNIVERSALE GRIGIA - APERTA

Grey universal rack base 50x25 - open

CODICE code	SCOMPARTI compartments	DIM. IN MM dim. in mm
RBASE5025	14	500x250

### RIALZO PER BASE UNIVERSALE BLU - APERTO

Blue universal extender 50x25 - open

CODICE code	SCOMPARTI compartments	DIM. IN MM dim. in mm
RALZB5025	14	500x250

### RIALZO PER PIATTINI VERDE

Green extender for saucers

CODICE code	SCOMPARTI compartments	DIM. IN MM dim. in mm
RALZPI	14	500x250

### DISTANZIATORE PER PIATTINI VERDE

Green keeper for base and extender

CODICE code	DIM. MM dim. mm
RDIST	500x250



## ALTRI CESTELLI PER LAVASTOVIGLIE

Other sizes of dishwasher racks



### CESTELLI 40X40 GRIGI

Grey rack base 40x40 cm

CODICE code	SCOMPARTI compartments	DIM. MM dim. mm
RBASE4040	aperta	400x400 mm
RBASE4040PV	per piatti e vassoi	400x400 mm



### CESTELLO UNIVERSALE 35,5X35,5

Grey rack base 355x355 mm

CODICE code	SCOMPARTI compartments	DIM. MM dim. mm
RBASE3535	aperta	355x355



### CESTELLO TONDO Ø 35 CON ANELLO

Round rack Ø 35 with ring

CODICE code	SCOMPARTI compartments	DIM. MM dim. mm
RBASET35R	aperta	Ø 350



### CESTELLO TONDO Ø 35 SENZA ANELLO

Round rack Ø 35 without ring

CODICE code	SCOMPARTI compartments	DIM. MM dim. mm
RBASET35	aperta	Ø 350



### CESTELLO TONDO Ø 38 SENZA ANELLO

Round rack Ø 38 without ring

CODICE code	SCOMPARTI compartments	DIM. MM dim. mm
RBASET38	aperta	Ø 380

### CESTELLO TONDO Ø 40 SENZA ANELLO

Round rack Ø 40 without ring

CODICE code	SCOMPARTI compartments	DIM. MM dim. mm
RBASET40	aperta	Ø 40





L'azienda Inox Macel nasce nei primi anni '80, quando la famiglia Salvi inizia ad affermarsi con articoli rivolti alle piccole e grandi macellerie. Già nei primissimi anni di attività la ditta allarga il proprio commercio oltre i confini nazionali. Anche la gamma di produzione viene ben presto ampliata: vassoi, contenitori ed articoli per gelateria ed altro ancora; una continua evoluzione che ha portato negli anni a una costante crescita per l'azienda. Con relazioni sviluppate alle più importanti manifestazioni fieristiche del settore in Italia, Europa, Asia ed America, la Inox Macel è attiva in tutti i continenti e può essere considerata una delle aziende più importanti del settore.

MADE IN ITALY è il concetto che meglio riassume la filosofia di INOX MACEL: qualità top nei materiali, funzionalità e durata nel tempo, design italiano.

*INOX MACEL was founded in the early 80's, when the Salvi family began offering products aimed at small and large butchers. Already in the first years the company expanded its business beyond national borders.*

*The production line soon expanded: trays, containers, articles for ice-cream shops and more. A continuous evolution that brought INOX MACEL to a steady growth over the years.*

*With connections developed at the most important fairs and shows in Italy, Europe, Asia and America, INOX MACEL is active in every continent, and can be considered one of the most important company in the sector.*

*MADE IN ITALY is the concept that summarizes best our corporate philosophy: high quality materials, durability, Italian design.*



See [www.nsf.com](http://www.nsf.com) for additional info and the complete list of certified products

**CERTIFICAZIONI** L'azienda INOX MACEL è certificata ISO9001:2015 per la progettazione e produzione di articoli atti al contatto con gli alimenti. NSF certifica la qualità dei prodotti, che sono rigorosamente testati nei laboratori CSI secondo tutte le norme di legge italiane ed europee.

**ESTERO** La rete di vendita è costituita esclusivamente da importatori-distributori sia in Italia che all'estero. I prodotti Inox Macel sono distribuiti nei migliori hotel, ristoranti, supermercati all'ingrosso in tutto il mondo.

**CERTIFICATES** *Our company is certified ISO9001:2015 for design and production of goods intended for food contact. NSF certifies the product high quality, while CSI independent laboratories rigorously test them accordingly with all Italian and EU rules and regulations.*

**OVERSEAS** *Our sales network is made of importers/distributors in Italy and abroad. INOX MACEL products are distributed to the best hotels, restaurants, wholesalers around the world.*



Inox Macel S.r.l.  
Sede legale: VIA DELLE MOIE 16/C  
25073 BOVEZZO (BS)  
Tel. +39 0302713265  
Fax +39 0302711041  
[inoxmacel@inoxmacel.com](mailto:inoxmacel@inoxmacel.com)  
[www.inoxmacel.it](http://www.inoxmacel.it)

N.REG IMPRESE E C.F E P.IVA 02462220985  
REA NR 451875 BRESCIA CAP. SOC. 400000,00 I.V.

[WWW.INOXMACEL.COM](http://WWW.INOXMACEL.COM)